

HOCHDRUCK

KÜHL-SCHMIERSTOFF-

LEITUNGSSYSTEME

AUS ROSTFREIEM STAHL

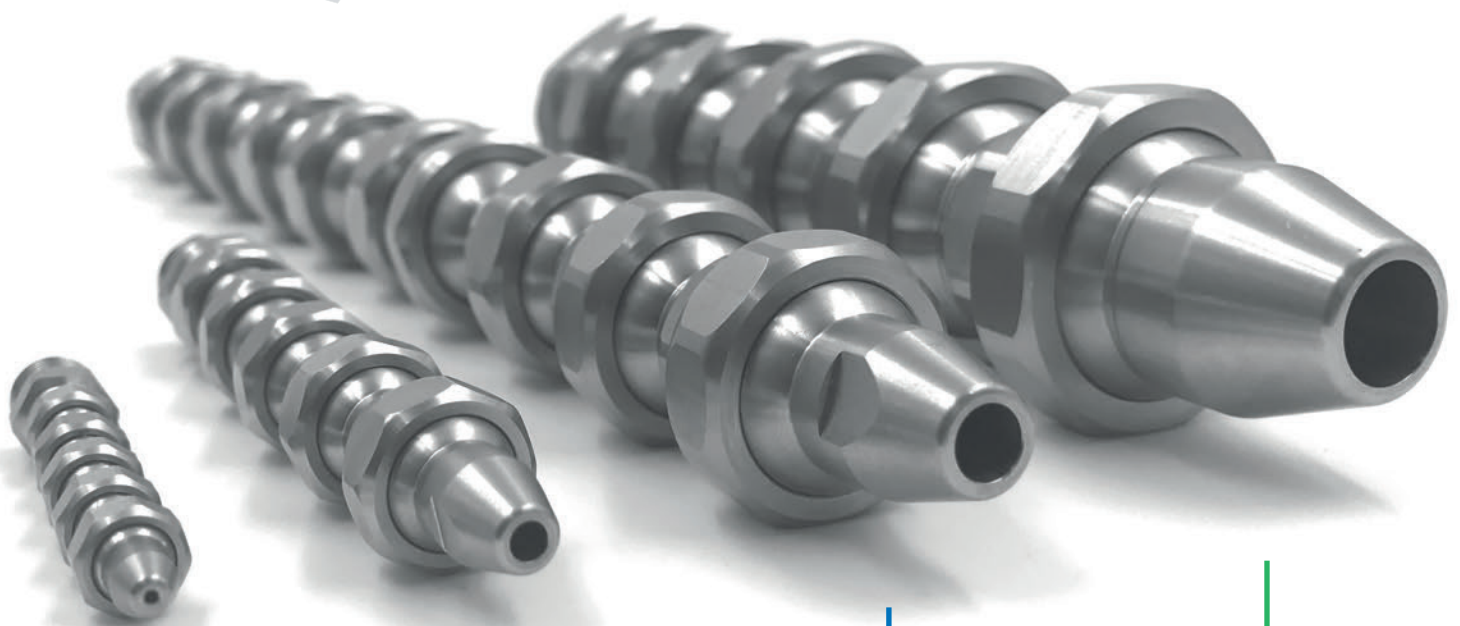

**Typ0**

1/8" System  
innen Ø 3,2 mm

**Typ1**

1/4" System  
innen Ø 5,8 mm

**Typ2**

1/2" System  
innen Ø 11 mm

**Typ 3**

3/4" System  
innen Ø 19 mm

INDIVIDUELL & FLEXIBEL

**Hirt**<sup>®</sup>  
LINE

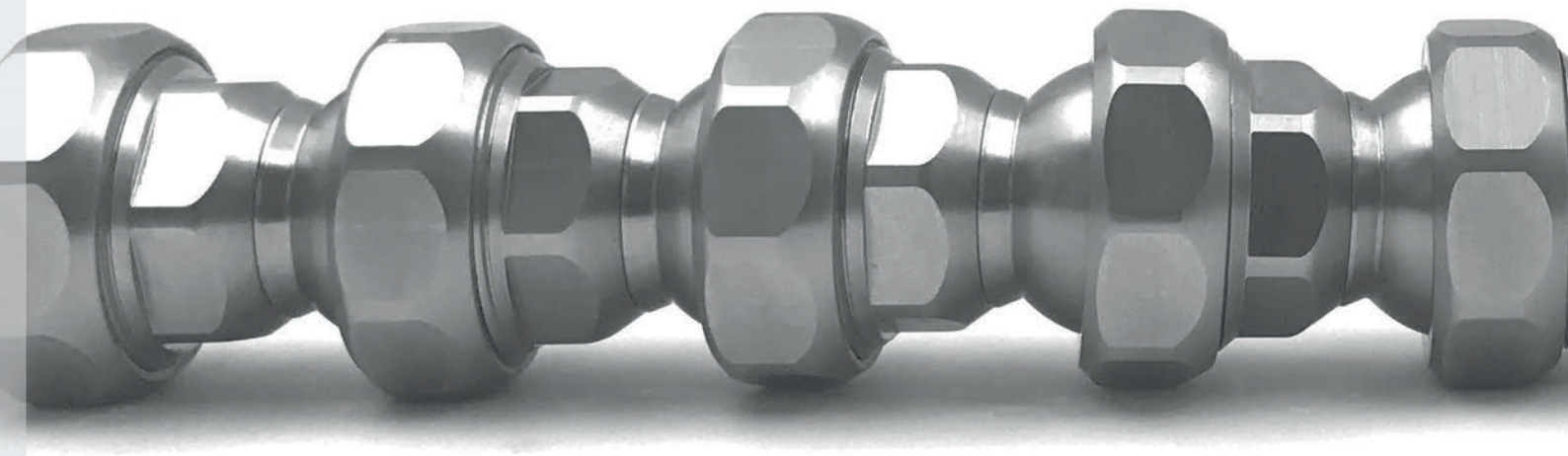

## Das Original Gelenkschlauch System | Hirt-Line®

Unser Gelenkschlauchsystem ist beliebig ausbaubar, rostfrei und bietet eine hohe Lebensdauer. Die Einzelteile sind präzisionsgefertigt und unempfindlich gegen Wärme und chemische Substanzen. Lässt sich einfach von Hand zusammenschrauben, anpassen, verlängern und kürzen. Weder Kühlmitteldruck noch Maschinenvibrationen können die Position verändern.

Druckbeständig über 100 bar. Einsetzbar an Werkzeugmaschinen und Fertigungsanlagen, vorwiegend an Drehmaschinen, Fräsmaschinen, Schleifmaschinen, Sägemaschinen und Abfüllanlagen. Geeignet für Emulsionen, Kühl- und Schneidöle, chemische Substanzen und zur Luftkühlung.

### Eigenschaften:

- Strahl punktgenau einstell-/ und fixierbar (verschraubbar)
- Resistent gegen hohe Temperaturen, chemischen Substanzen, Späne, Druck und Vibrationen
- Korrosionsbeständiges Material 1.4305 V2A (auf Anfrage in V4A)
- Verschleißfest
- Druckstabil über 100 bar
- Einsatzbereich -30°C bis +60°C
- Optional ES-System bis +300°C (auf Anfrage erhältlich)
- 4 Systemgrößen, alle untereinander kompatibel
- Hohe Lebensdauer
- Direkt am Werkzeug einsetzbar (AGW-Anschluss)
- Vielseitig kombinierbar
- Durchdachtes und effektives Sortiment
- Einsetzbar in der Lebensmittelindustrie
- Anschlusselemente für jede Maschine
- Grundsets in jedem System



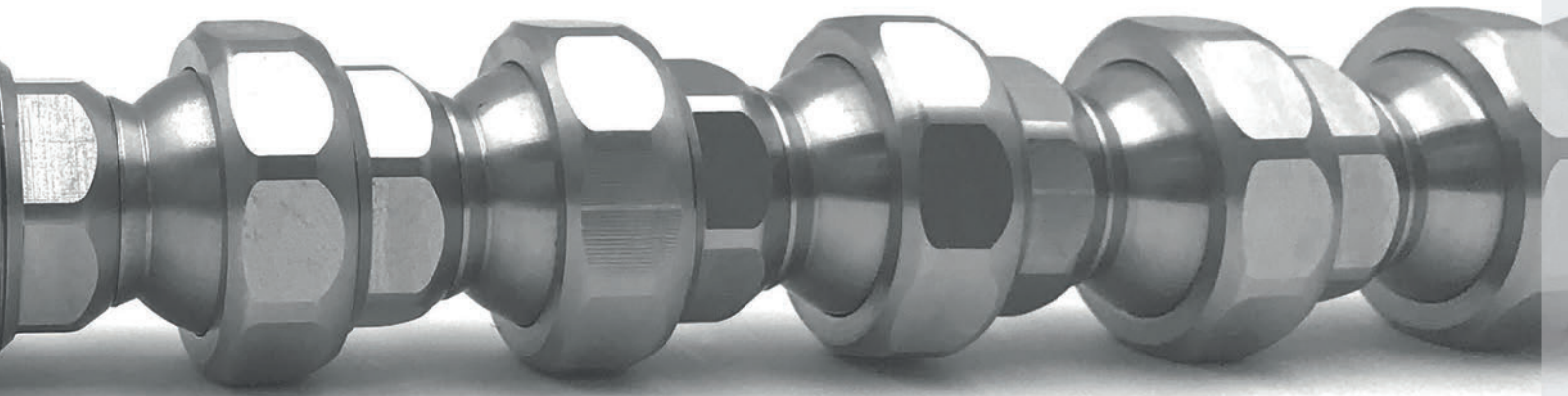

## Höhere Werkzeugstandzeiten und weniger Maschinenstillstand für Werkzeugmaschinen

Kunststoff-Gelenkschläuche sind zwar sehr flexible Kühlmittel-Leitungen, bieten aber nur bedingt die geforderte Betriebssicherheit. Standard Gelenkschläuche werden häufig durch Vibrationen oder Späne verstellt und das Kühlmittel gelangt nicht mehr dahin, wo es von

Nutzen ist. Maschinenstillstände bis hin zu Werkzeugschäden sind teuer und können vermieden werden. Mit unserem herstellerunabhängigen Hirt-Line® Kühl-Schmierstoff-Leitungssystem für Dreh-, Fräs- und Schleifmaschinen steigern Sie Ihre Produktivität.

## MADE IN SWITZERLAND ist das Qualitätsversprechen von Hirt-Line®

Dem verpflichten wir uns durch die eigene, flexible Fertigung und einem hohen Qualitätsanspruch. Ob Serienfertigung

von Standardprodukten oder Einzelanfertigung von Sonderlösungen - wir sind gerne für Sie da!



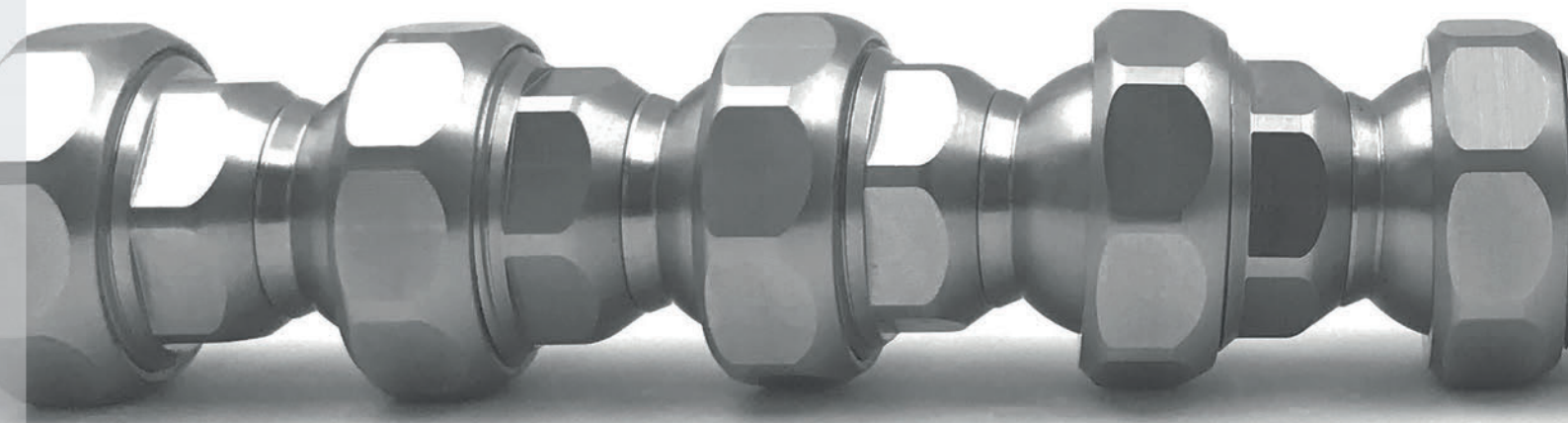

## 4 Systemgrößen

**Typ0** | 1/8" | Durchlass Ø 3,2 mm | Gewinde M8 x 0,75

**Typ1** | 1/4" | Durchlass Ø 5,8 mm | Gewinde M14 x 1,0

**Typ2** | 1/2" | Durchlass Ø 11,0 mm | Gewinde M24 x 1,0

**Typ3** | 3/4" | Durchlass Ø 19,0 mm | Gewinde M34 x 1,0

**Alle untereinander kompatibel**



## Maschinenadapter

Neben den Standard Rohrgewinde G1/8", G1/4", G3/8", G1/2", G3/4", G1" sowie Metrischen M5 x 0,8 über M14 x 1,0 bis M20 x 1,5, bieten wir auch konische Gewinde und Kugelkopfadapter mit den Maßen Ø10 mm, Ø12 mm, Ø14 mm, Ø15 mm an, dazu diverse Spezial-Adapter.

Auf Anfrage erhalten Sie Ihren Spezial-Anschlussadapter!



## Grundelemente

3,2 mm, 5,8 mm, 11,0 mm und 19,0 mm Innendurchmesser messen die Grundelemente des Hirt-Line Systems. Die Vielzahl verschiedener Standard Längen von 9,3 mm über 100 mm bis hin zu 1000 mm machen ein exaktes Einrichten und Fixieren des Kühlstrahls an der gewünschten Stelle möglich. Und sorgen so für ein effektives und einfaches Anpassen. Andere Längen auf Spezialanfertigung möglich.



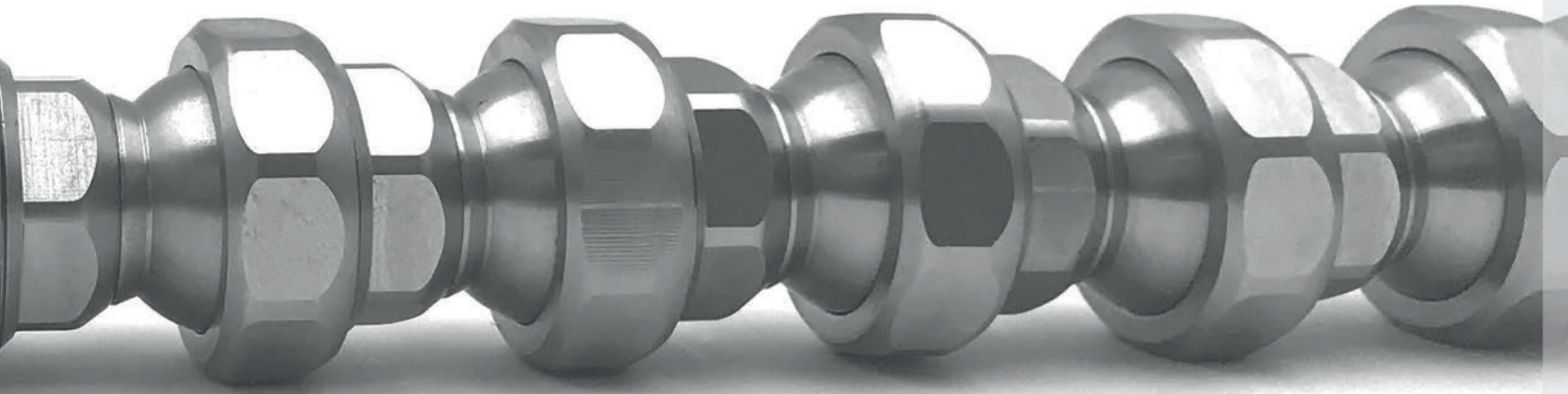

## Winkelemente

Das Hirt-Line® System bietet viele verschiedene Winkelemente in jeder Systemgröße, ob Typ 0, Typ 1, Typ 2, oder Typ 3 wir haben das Passende wie z.B. Winkelstücke 90°, Mehrfachverbindungen, T- und Y-Stücke. Durch die große Auswahl sorgen wir so für eine möglichst große Flexibilität des Systems. Spezial-Verschraubungen auf Anfrage!



## Düsen

Die Düsen aus einem Werkstoff 1.4305 (V2A) sind gegen Wärme unempfindlich und ab Ø0,5 mm, über Ø10,0 mm bis hin zu Ø19,0 mm Durchlass erhältlich. Unsere zahlreichen Flachdüsen mit verschiedenen Schlitzbreiten lassen keine Wünsche offen; zum Schwemmen oder kühlen sowie Flach- und Rundschleifen bestens geeignet. Hinzu kommen einige speziell Düsen, entweder mit mehreren Bohrungen oder Mini-Schlitzen. Optimiert für eine perfekte Kühlung!

## Zubehör

Das Hirt-Line® Zubehör besteht aus eigenen Produkten wie Schnellkupplungen, Rändelmuttern oder Verschlusskappen, dazu Reduktionen um die einzelnen Systeme miteinander zu kombinieren. Passende externe Artikel z.B. Kugelhähne und Maulschlüssel bieten wir mit an. Mit diesem Sortiment sichern Sie sich auch für die Zukunft eine optimale und stabile Kühlmittelzufuhr, besonders für individuelle Anwendungen.



Alle Artikel erhältlich in verschiedenen Größen und in jedem System.  
(Beispielbild Typ2 System)



## Ein Baukasten, der überzeugt!

Das Hirt-Line<sup>®</sup> System kann die Basis einer erfolgreichen Produktion sein. Die Basis für das System wiederum sind seine einzelnen Komponenten. Um Kunden die Möglichkeit zu eröffnen, bei der Gestaltung und Umsetzung ihrer Anlagen ganz eigene Wege zu gehen, macht Hirt-Line<sup>®</sup> alle Komponenten und deren Daten hier einzeln verfügbar. Hirt-Line<sup>®</sup> hat alle seine Elemente in einem Katalog für schnelle und einfache Bestellung zusammengestellt.

## PRODUKTÜBERSICHT

Typ0 [1/8"]

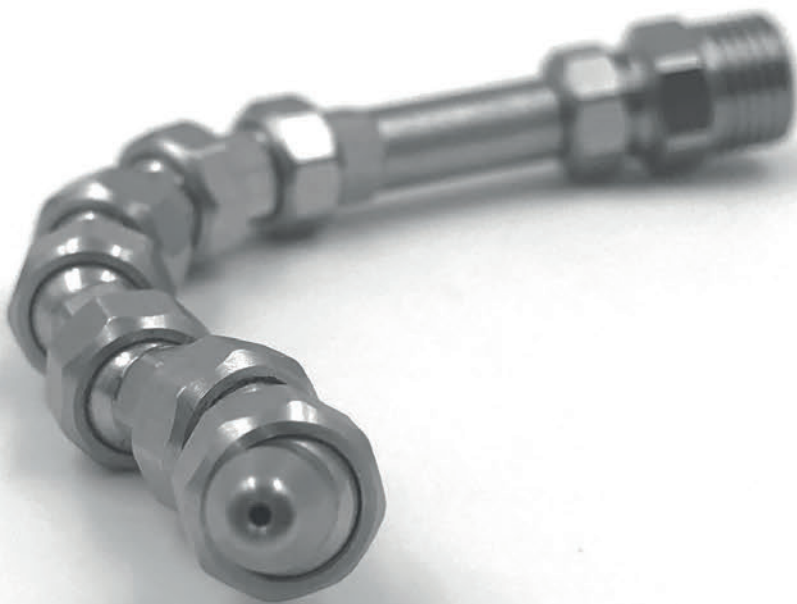

Das neueste Typ0 System ist schnell montiert, lässt sich einfach auf das Werkzeug einrichten und beinhaltet eine Vielzahl an passenden Düsen von Ø0,5 mm über Ø3,0 mm bis hin zu Düsen mit mehreren Auslässen. Ein großes Sortiment an Maschinenadapter von M5x0,8 über M10x1,5 bis hin zu Kugeladapter mit Ø10,0 mm und natürlich auch wieder verschiedene Grund- und Winkelemente gewähren dem Anwender die nötige Flexibilität und Variabilität bei der Bearbeitung ihrer Produkte.

**TECHNISCHE DATEN:**

- Größe Typ0 (1/8")
- Durchlass  $\varnothing$  3,2 mm
- Druckbeständig bis 80 bar
- Einsatzbereich -30°C bis +60°C
- Optional ES-System bis +300°C (auf Anfrage erhältlich)
- Gewinde (Elemente) M8x0,75
- Material 1.4305 (V2A)

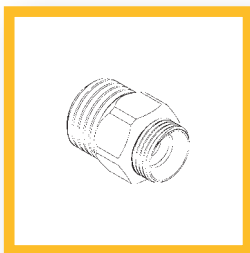
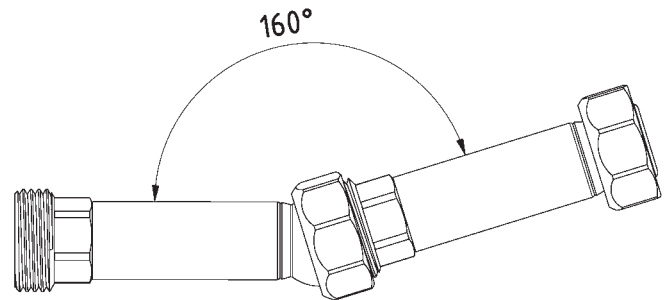
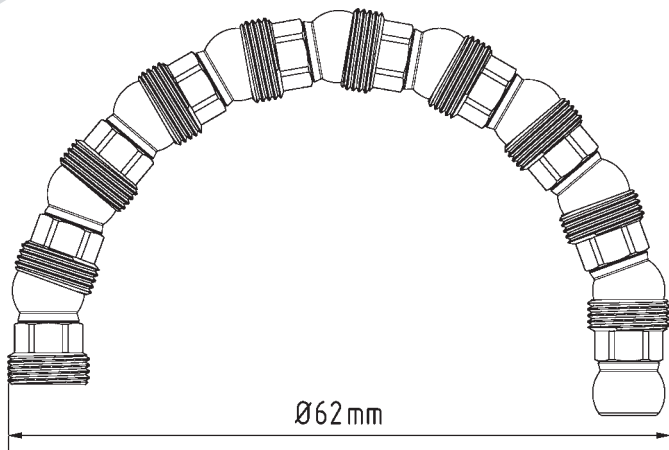

MASCHINENADAPTER

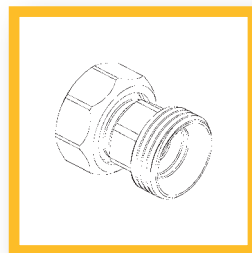

GRUNDELEMENTE

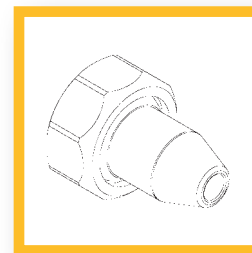

DÜSEN

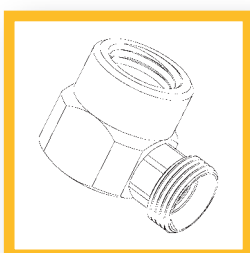

WINKELEMENTE

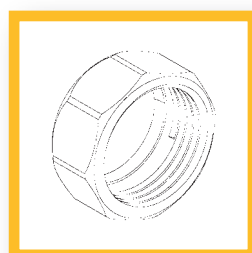

ZUBEHÖR

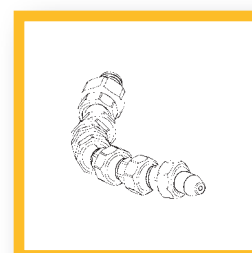

GRUNDSET Typ0



# Typ0 [1/8" System]

## Grundelemente | Basic Elements

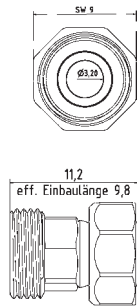

### O-GE

l = 11,2 mm effektiv l = 9,8 mm  
l = 11,2 mm effective l = 9,8 mm

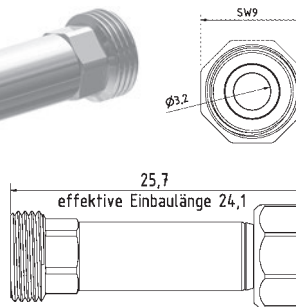

### O-GE-25

l = 25,7 mm effektiv l = 24,1 mm  
l = 25,7 mm effective l = 24,1 mm

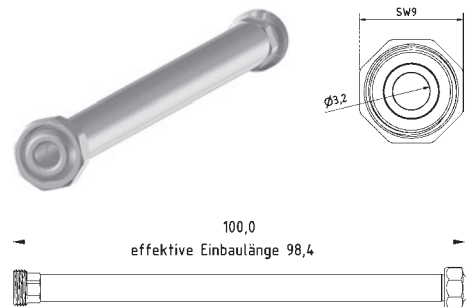

### O-GE-100

l = 100 mm effektiv l = 98,4 mm  
l = 100 mm effective l = 98,4 mm

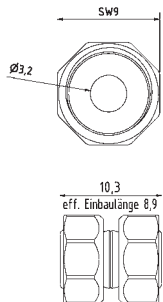

### O-GE-DK

l = 10,3 mm effektiv l = 8,9 mm Doppelkugel  
l = 10,3 mm effective l = 8,9 mm double ball

## Maschinen-/Düsenadapter | Machine-/Nozzle Adapter

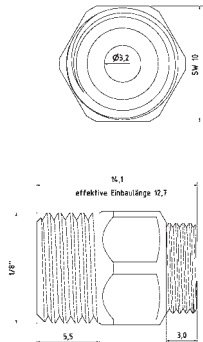

### O-AD-18

Adapterstück G 1/8"  
adaptor piece thread 1/8"

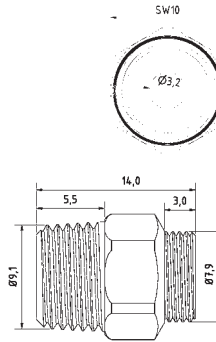

### O-AD-18-PT

Adapterstück G 1/8" PT (Withworth-Gewinde)  
adaptor piece thread 1/8" PT (NPT thread)

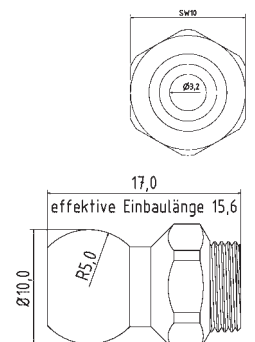

### O-AD-K10

Adapterstück Kugel Ø10  
adaptor piece ball Ø10

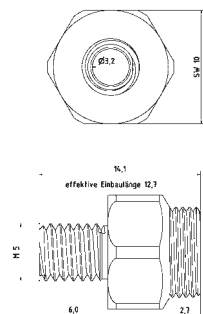
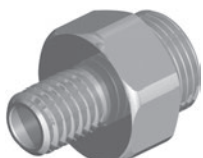

### O-AD-M5

Adapterstück M 5 x 0,8  
adaptor piece M 5 x 0,8 metric thread

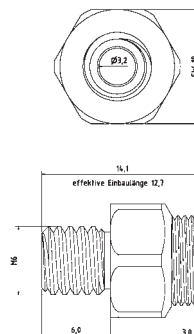

### O-AD-M6

Adapterstück M 6 x 1  
adaptor piece M 6 x 1 metric thread

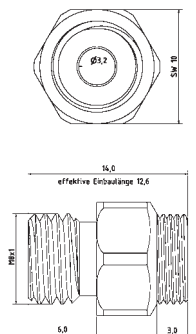

### O-AD-81

Adapterstück M 8 x 1  
adaptor piece M 8 x 1 metric thread

**Maschinen-/Düsenadapter | Machine-/Nozzle Adapter**

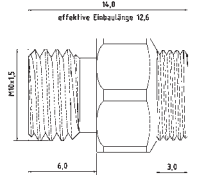
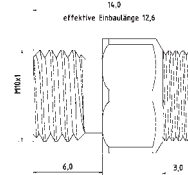
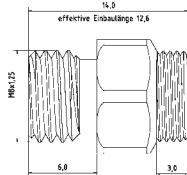
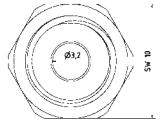
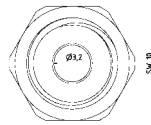
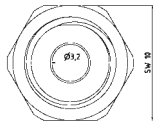

**O-AD-M8**

Adapterstück M 8 x 1,25  
adaptor piece M 8 x 1,25 metric thread

**O-AD-M101**

Adapterstück M 10 x 1  
adaptor piece M 10 x 1 metric thread

**O-AD-M10**

Adapterstück M 10 x 1,5  
adaptor piece M 10 x 1,5 metric thread

**Winkелеlemente | Elbows**

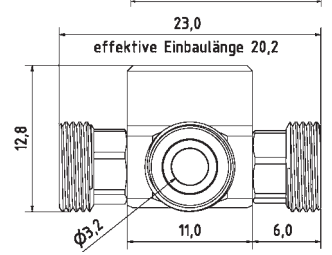
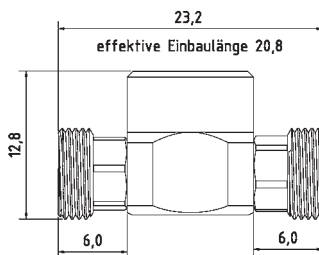
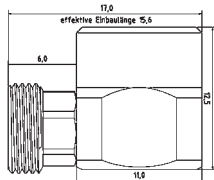
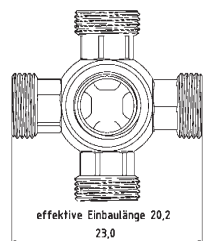
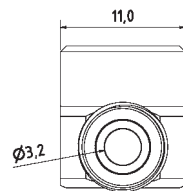
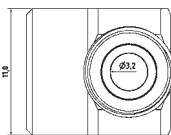
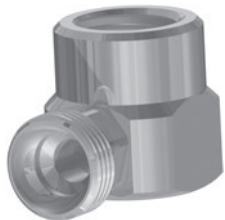

**O-WV-1**

Winkelverschraubung  
elbow piece fixed

**O-WV-2**

T-Stück  
T-piece fixed

**O-WV-4**

Mehrfachverteiler  
Manifold

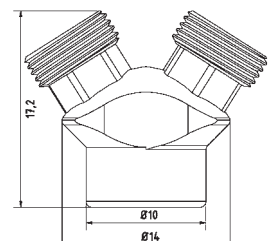
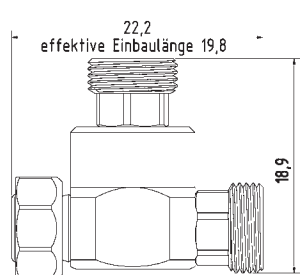
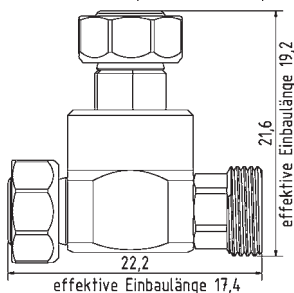
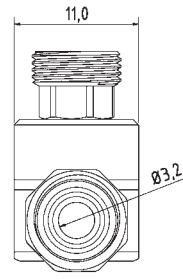
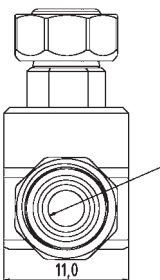
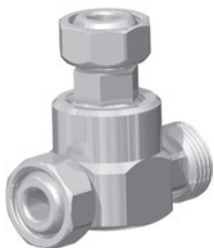

**O-WV-R**

Verschlussstück zu Ringdüse  
locking tappet to ring nozzle

**O-WV-R-2K**

T-Stück für Ring und Düse  
T-piece for ring and nozzle

**O-YV**

Y-Stück  
Y-piece fixed

# Typ0 [1/8" System]

## Düsen | Nozzles

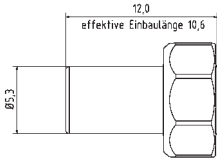
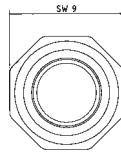

### 0-DU-0

Düse ohne Bohrung  
nozzle straight without drilling

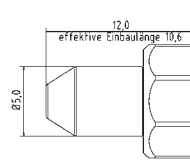
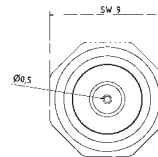

### 0-DU-05

Düse gerade Bohrung Ø 0,5 mm  
nozzle straight Ø 0,5 mm

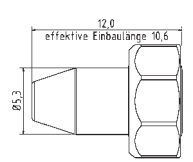
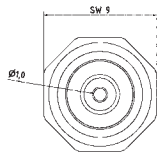
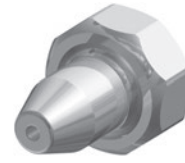

### 0-DU-10

Düse gerade Bohrung Ø 1,0 mm  
nozzle straight Ø 1,0 mm

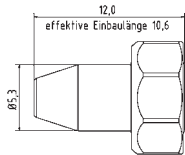
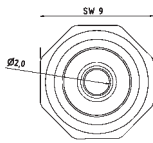

### 0-DU-20

Düse gerade Bohrung Ø 2,0 mm  
nozzle straight Ø 2,0 mm

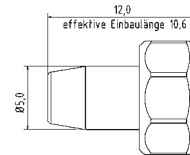
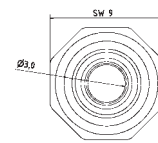

### 0-DU-30

Düse gerade Bohrung Ø 3,0 mm  
nozzle straight Ø 3,0 mm

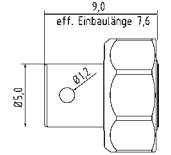
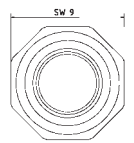
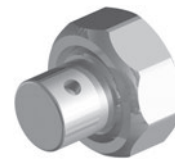

### 0-DU-90-1

Düse 90° Bohrung 1 x Ø 1,2 mm  
nozzle 90° drill hole 1 x Ø 1,2 mm

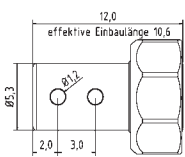
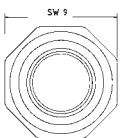

### 0-DU-90-2

Düse 90° Bohrung 2 x Ø 1,2 mm  
nozzle 90° drill hole 2 x Ø 1,2 mm

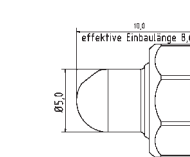
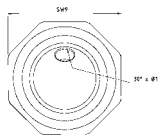
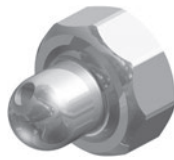

### 0-DU-30-1.5

Düse 30° Bohrung Ø 1,5 mm  
nozzle 30° drill hole Ø 1,5 mm

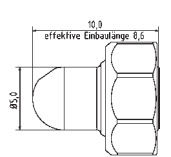
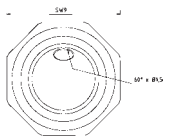
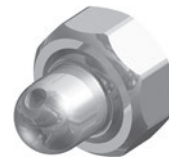

### 0-DU-60-1.5

Düse 60° Bohrung Ø 1,5 mm  
nozzle 60° drill hole Ø 1,5 mm

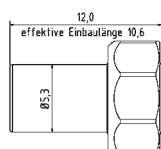
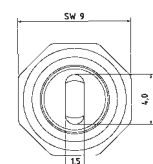

### 0-DU-415

Düse mit Schlitz 4 x 1,5 mm  
nozzle straight with slit 4 x 1,5 mm

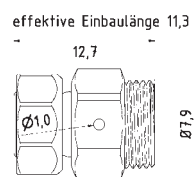
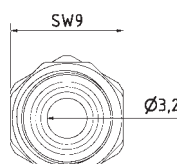

### 0-DU-R

Ringdüsen Element Bohrung Ø 1,0 mm  
ring nozzle element drill hole Ø 1,0 mm

**Zubehör | Accessories**

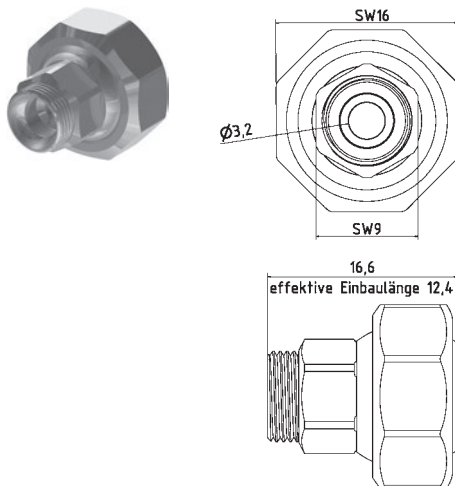

**RE-1-0**

Reduktion Typ 1 auf Typ 0  
*reduction Type 1 to Type 0*



**SW-6**

Schlüssel aus Stahl SW 6  
*open end wrench SW 6*



**SW-9**

Schlüssel aus Stahl SW 9  
*open end wrench SW 9*

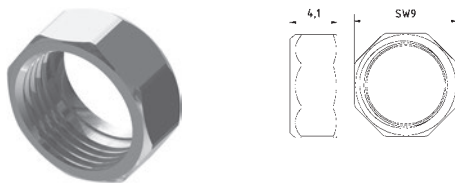

**0-MU**

Mutter Standard  
*screw nut (default)*

**Grundset | Basic Set**

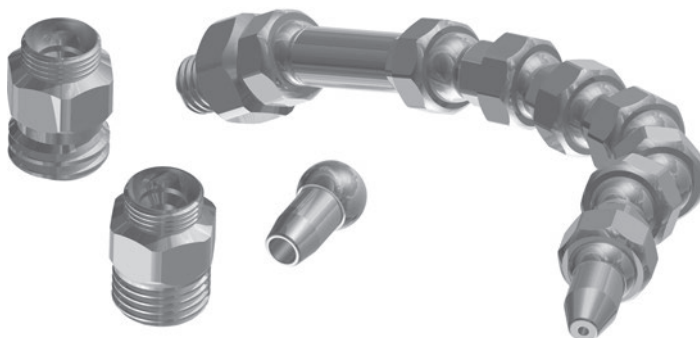

**0-GS**

Grundset Typ0 1/8" Zoll System L = 110 mm  
*basic set Type0 1/8" system l = 110 mm*

6 x 0-GE, 1 x 0-GE-25, 1 x 0-AD-18, 1 x 0-AD-M6, 1 x 0-AD-101, 1 x 0-DU-10  
1 x 0-DU-30, 1 x SW-6, 1 x SW-9



**0-GS-R**

Ringdüsen Set Ø = 60mm  
*(1 x 0-WV-R, 20 x 0-DU-R)*

ring nozzle set Ø = 60mm  
*(1 x 0-WV-R, 20 x 0-DU-R)*

# PRODUKTÜBERSICHT

## Typ1 [1/4"]

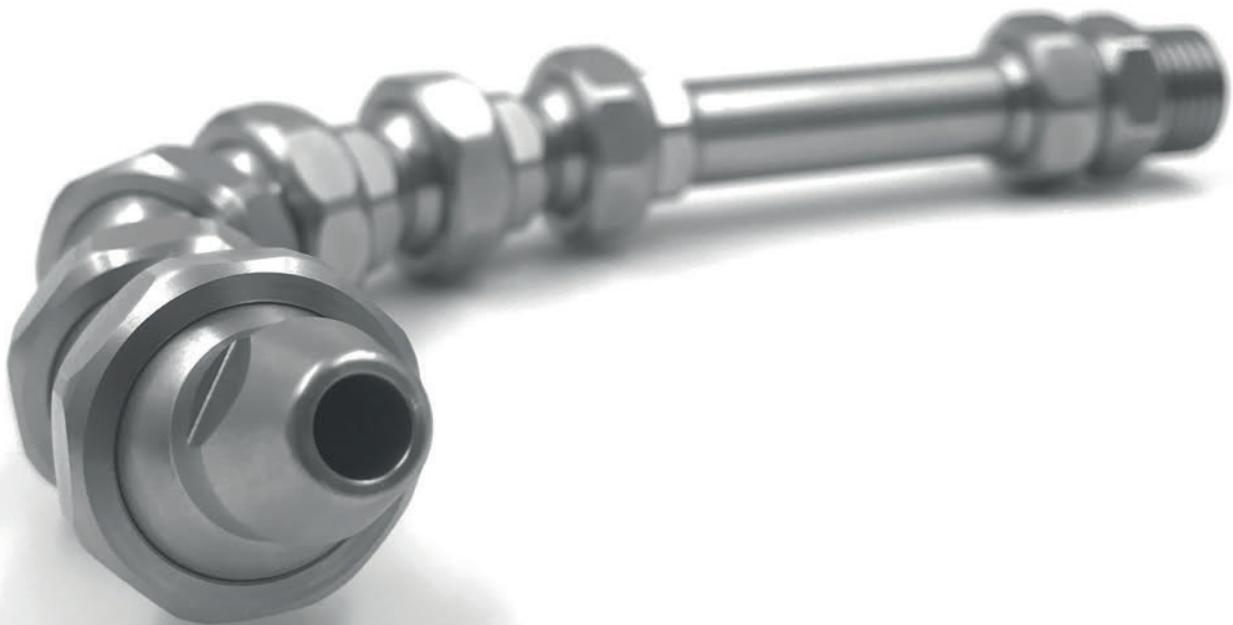

Das Typ1 System für alle Maschinen-Anwendungen im Bereich bis max.  $\pm 170$ l/min. Mit Runddüsen Größen von  $\varnothing 1,6$  mm bis  $\varnothing 5,0$  mm und eine Vielzahl an Flachdüsen und Düsen mit mehreren Bohrungen ist dieses System ein Standard für jede Maschine. Das große Sortiment an Maschinenadapter von M8x1,0 über M14x1,5 und G3/8" bis hin zu verschiedenen Kugeladapter mit  $\varnothing 14,0$  mm und natürlich auch wieder Grund- und Winkelelemente garantieren für eine reibungslose Installation.

**TECHNISCHE DATEN:**

- Größe Typ1 (1/4")
- Durchlass Ø 5,8 mm
- Druckbeständig über 100 bar
- Einsatzbereich -30°C bis +60°C
- Optional ES-System bis +300°C (auf Anfrage erhältlich)
- Gewinde (Elemente) M14x1
- Material 1.4305 (V2A)

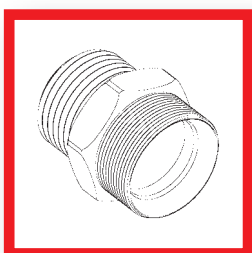
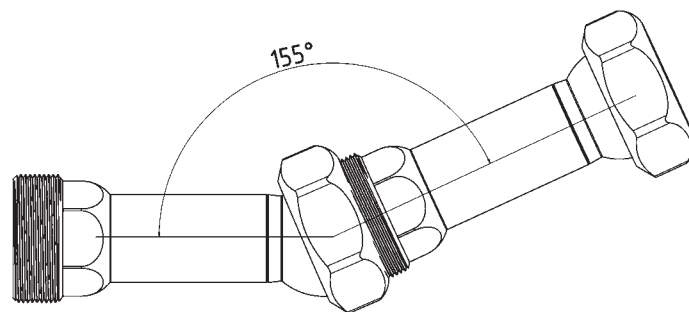
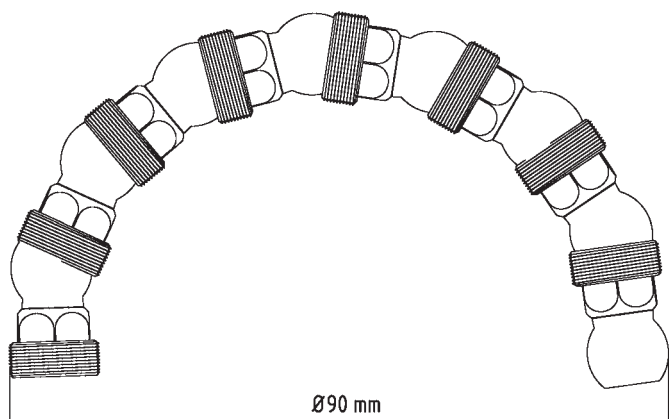

MASCHINENADAPTER

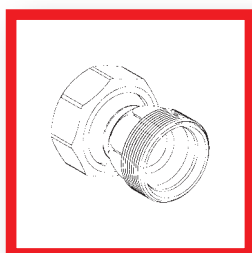

GRUNDELEMENTE

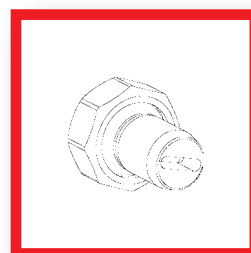

DÜSEN

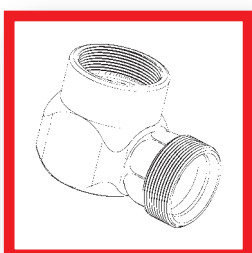

WINKELELEMENTE

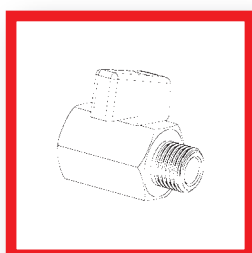

ZUBEHÖR

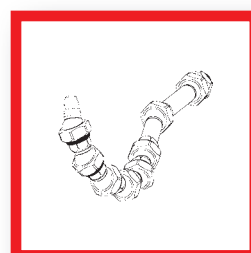

GRUNDSET Typ1

# Typ1 [1/4" System]

## Grundelemente | Basic Elements

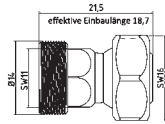
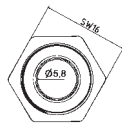
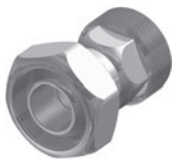

### 1-GE

$l = 21,5$  mm effektiv  $l = 18,7$  mm  
 $l = 21,5$  mm effective  $l = 18,7$  mm

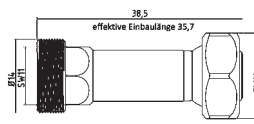
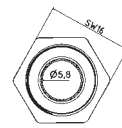

### 1-GE-2

$l = 38,5$  mm effektiv  $l = 35,7$  mm  
 $l = 38,5$  mm effective  $l = 35,7$  mm

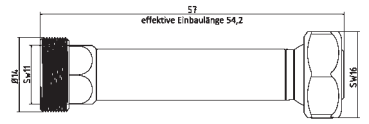
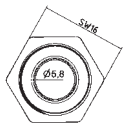

### 1-GE-3

$l = 57$  mm effektiv  $l = 54,2$  mm  
 $l = 57$  mm effective  $l = 54,2$  mm

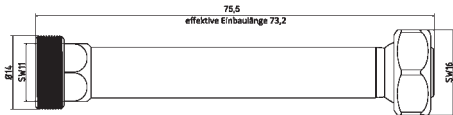
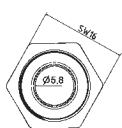

### 1-GE-4

$l = 75,5$  mm effektiv  $l = 73,2$  mm  
 $l = 75,5$  mm effective  $l = 73,2$  mm

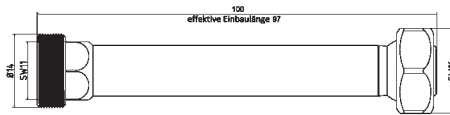
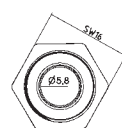

### 1-GE-100

$l = 100$  mm effektiv  $l = 97$  mm  
 $l = 100$  mm effective  $l = 97$  mm

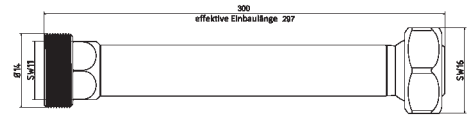
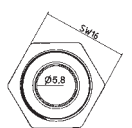

### 1-GE-300

$l = 300$  mm effektiv  $l = 297$  mm  
 $l = 300$  mm effective  $l = 297$  mm

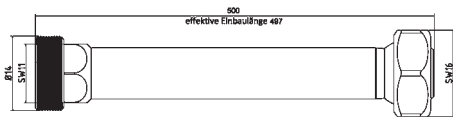
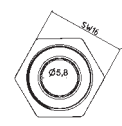

### 1-GE-500

$l = 500$  mm effektiv  $l = 497$  mm  
 $l = 500$  mm effective  $l = 497$  mm

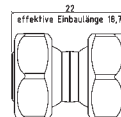
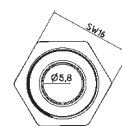
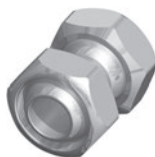

### 1-GE-DK

$l = 22$  mm effektiv  $l = 18,7$  mm Doppelkugel  
 $l = 22$  mm effective  $l = 18,7$  mm double ball

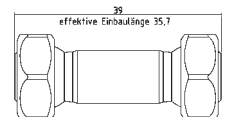
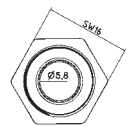

### 1-GE-2-DK

$l = 39$  mm effektiv  $l = 35,7$  mm Doppelkugel  
 $l = 39$  mm effective  $l = 35,7$  mm double ball

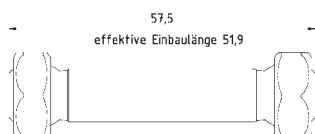
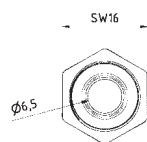

### 1-GE-3-DK

$l = 57,5$  mm effektiv  $l = 51,9$  mm Doppelkugel  
 $l = 57,5$  mm effective  $l = 51,9$  mm double ball

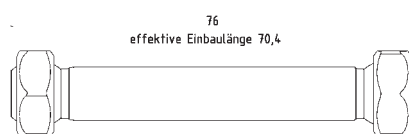
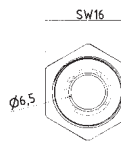

### 1-GE-4-DK

$l = 76$  mm effektiv  $l = 70,4$  mm Doppelkugel  
 $l = 76$  mm effective  $l = 70,4$  mm double ball

**Maschinen-/Düsenadapter | Machine-/Nozzle Adapter**

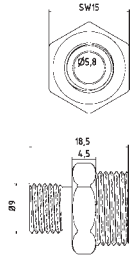
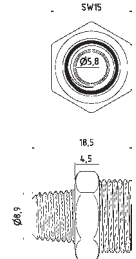
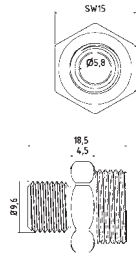

**1-AD-18**

Adapterstück G 1/8"  
adaptor piece thread 1/8"

**1-AD-18-PT**

Adapterstück G 1/8" PT (Withworth-Gewinde)  
adaptor piece thread 1/8" PT (NPT thread)

**1-AD-18-U**

Adapterstück G 1/8" U (Gewinde unterschritten)  
adaptor piece thread 1/8" U (Undercut thread)

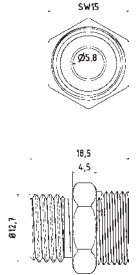
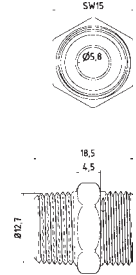
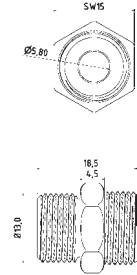

**1-AD-14**

Adapterstück G 1/4"  
adaptor piece thread 1/4"

**1-AD-14-PT**

Adapterstück G 1/4" PT (Withworth-Gewinde)  
adaptor piece thread 1/4" PT (NPT thread)

**1-AD-14-U**

Adapterstück G 1/4" U (Gewinde unterschritten)  
adaptor piece thread 1/4" U (Undercut thread)

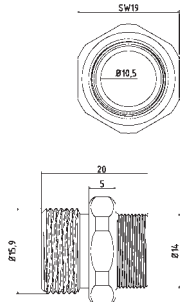
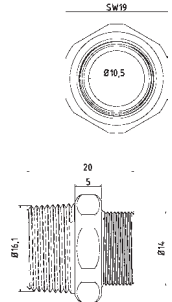
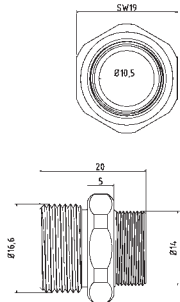

**1-AD-38**

Adapterstück G 3/8"  
adaptor piece thread 3/8"

**1-AD-38-PT**

Adapterstück G 3/8" PT (Withworth-Gewinde)  
adaptor piece thread 3/8" PT (NPT thread)

**1-AD-38-U**

Adapterstück G 3/8" U (Gewinde unterschritten)  
adaptor piece thread 3/8" U (Undercut thread)

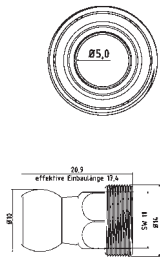
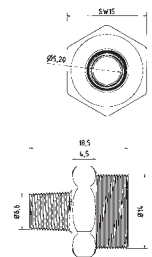
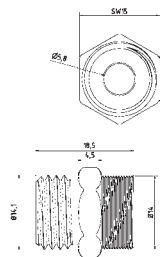

**1-AD-9-16-20UNF**

Adapterstück G 9/16"  
adaptor piece thread 9/16"

**1-AD-1-16PT**

Adapterstück G 1/16" PT (Withworth-Gewinden)  
adaptor piece thread 1/16" PT (NPT thread)

**1-AD-K10**

Adapterstück Kugel Ø 10 (z.B. Traub)  
adaptor piece ball Ø 10 mm (e.g. Traub)



# Typ1 [1/4" System]

## Maschinen-/Düsenadapter | Machine-/Nozzle Adapter

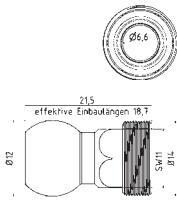

### 1-AD-K12

Adapterstück Kugel Ø 12 (z.B. MORI SEIKI)  
*adaptor piece ball Ø 12 mm (e.g. MORI SEIKI)*

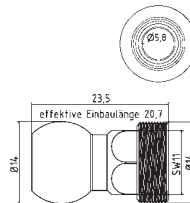

### 1-AD-K14

Adapterstück Kugel Ø 14 (z.B. Wenk)  
*adaptor piece ball Ø 14 mm (e.g. Wenk)*

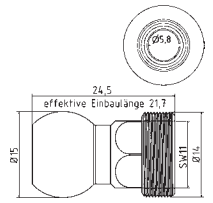

### 1-AD-K15

Adapterstück Kugel Ø 15 (z.B. Okuma)  
*adaptor piece ball Ø 15 mm (e.g. Okuma)*

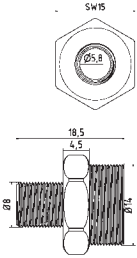

### 1-AD-81

Adapterstück M8 x 1  
*adaptor piece M8 x 1 metric thread*

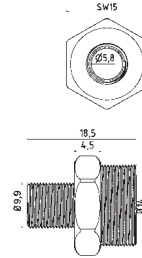

### 1-AD-101

Adapterstück M10 x 1  
*adaptor piece M10 x 1 metric thread*

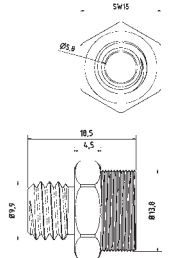

### 1-AD-101.5

Adapterstück M10 x 1.5  
*adaptor piece M10 x 1.5 metric thread*

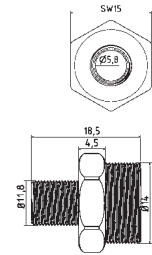

### 1-AD-121

Adapterstück M 12 x 1  
*adaptor piece M 12 x 1 metric thread*

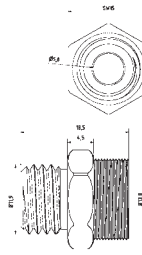

### 1-AD-121.5

Adapterstück M 12 x 1,5  
*adaptor piece M 12 x 1,5 metric thread*

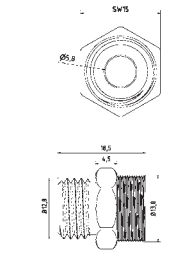

### 1-AD-131.5

Adapterstück M 13 x 1,5  
*adaptor piece M 13 x 1,5 metric thread*

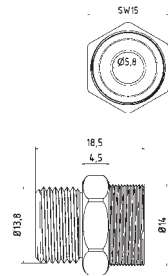

### 1-AD-141

Adapterstück M 14 x 1  
*adaptor piece M 14 x 1 metric thread*

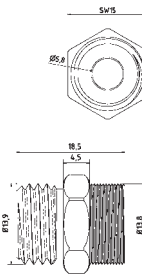

### 1-AD-141.5

Adapterstück M 14 x 1,5  
*adaptor piece M 14 x 1,5 metric thread*

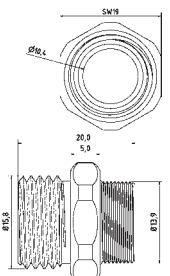

### 1-AD-161.5

Adapterstück M 16 x 1,5  
*adaptor piece M 16 x 1,5 metric thread*

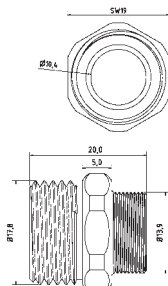

### 1-AD-181.5

Adapterstück M 18 x 1,5  
*adaptor piece M 18 x 1,5 metric thread*

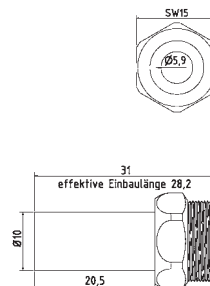

### 1-AD-10L

Adapterstück zu Hydraulik-Verschraubung 10 L  
*adaptor piece to hydraulic system 10 L*

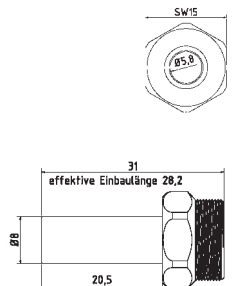

### 1-AD-8L

Adapterstück zu Hydraulik-Verschraubung 8 L  
*adaptor piece to hydraulic system 8 L*

## Maschinen-/Düsenadapter | Machine-/Nozzle Adapter

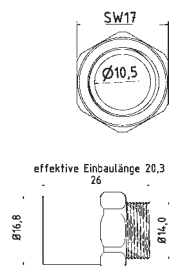

### 1-AD-I121-Typ1

Adapterstück M12 x 1 Innengewinde auf Hirt-Line Typ1 Aussengewinde  
adaptor piece M12 x 1 female thread to Hirt-Line type1 male thread

### 1-AD-I121.5-Typ1

Adapterstück M12 x 1.5 Innengewinde auf Hirt-Line Typ1 Aussengewinde  
adaptor piece M12 x 1.5 female thread to Hirt-Line type1 male thread

### 1-AD-I141.5-Typ1

Adapterstück M14 x 1.5 Innengewinde auf Hirt-Line Typ1 Aussengewinde  
adaptor piece M14 x 1.5 female thread to Hirt-Line type1 male thread

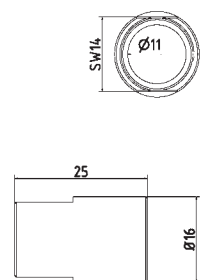
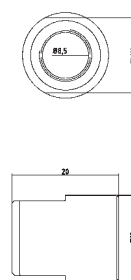
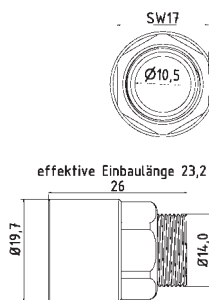

### 1-AD-I161.5-Typ1

Adapterstück M16 x 1.5 Innengewinde auf Hirt-Line Typ1 Aussengewinde  
adaptor piece M16 x 1.5 female thread to Hirt-Line type1 male thread

### 1-AD-1GE-18

Adapterstück für Fremddüsen mit Außengewinde, IG 1-GE auf IG 1/8"  
adapter piece for external nozzles with male thread, female 1-GE to female 1/8"

### 1-AD-1GE-14

Adapterstück für Fremddüsen mit Außengewinde, IG 1-GE auf IG 1/4"  
adapter piece for external nozzles with male thread, female 1-GE to female 1/4"

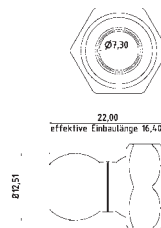

### 1-AD-LL

Adapterstück Loc-Line Typ 1  
adaptor piece Loc-Line Type 1

## Winkelelemente | Elbows

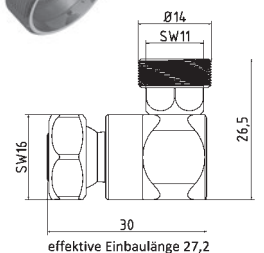
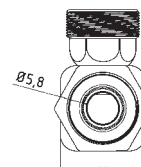
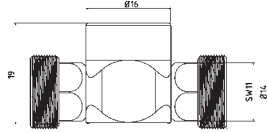
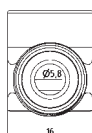

### 1-WV-1

Winkelverschraubung  
elbow piece fixed

### 1-WV-2

T-Stück  
T-piece fixed

### 1-WV-1K

Winkelverschraubung mit Kugelstück  
elbow piece moveable

# Typ1 [1/4" System]

## Winkelemente | Elbows

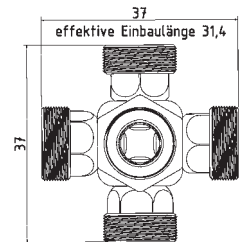
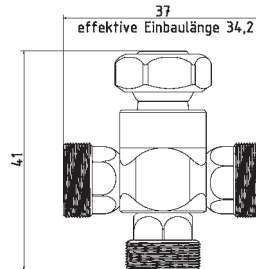
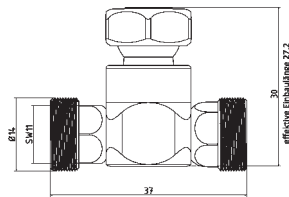
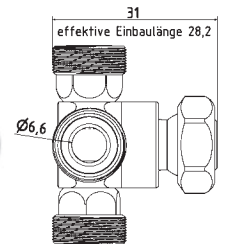
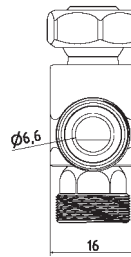
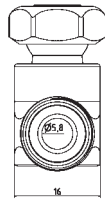
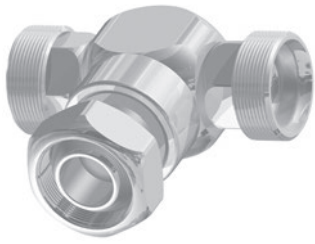

### 1-WV-2K

T-Stück mit Kugelstück  
*T-piece moveable*

### 1-WV-3K

Kreuz-Stück mit Kugelstück  
*cross piece moveable*

### 1-WV-4K

Stern-Stück mit Kugelstück  
*star piece moveable*

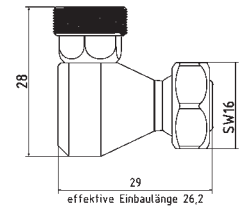
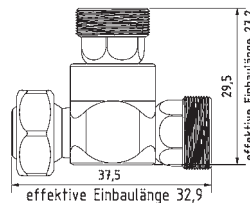
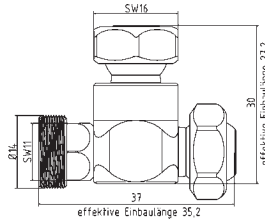
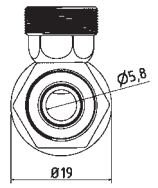
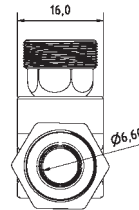
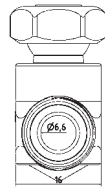

### 1-WV-R

Verschlussstück zu Ringdüse  
*locking tappet to ring nozzle*

### 1-WV-R-2K

T-Stück für Ring und Düse  
*T-piece for ring and nozzle*

### 1-WI

Winkelstück für Leitungen  
*corner piece for pipelines*

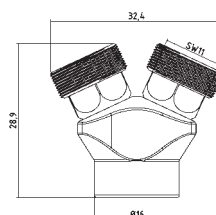
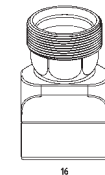

### 1-YV

Y-Stück 50°  
*Y-piece 50°*

## Düsen | Nozzles

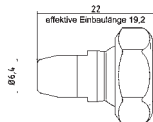
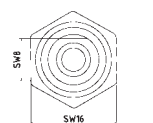
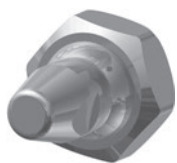

### 1-DU-0

Düse ohne Bohrung  
nozzle straight without drilling

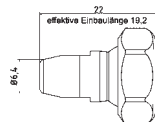
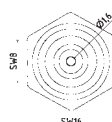
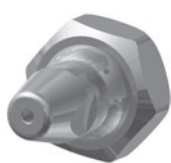

### 1-DU-16

Düse gerade Bohrung Ø 1,6 mm  
nozzle straight Ø 1,6 mm

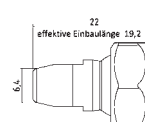
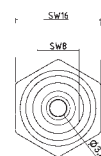

### 1-DU-32

Düse gerade Bohrung Ø 3,2 mm  
nozzle straight Ø 3,2 mm

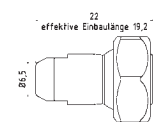
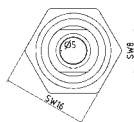

### 1-DU-50

Düse gerade Bohrung Ø 5,0 mm  
nozzle straight Ø 5,0 mm

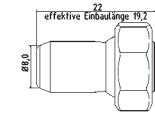
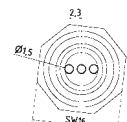

### 1-DU-3-16

Düse gerade Bohrung 3 x Ø 1,6 mm  
nozzle straight 3 x Ø 1,6 mm

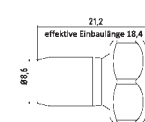
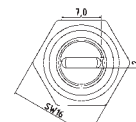

### 1-DU-72

Düse mit Schlitz 7 x 2,0 mm  
nozzle straight with slit 7 x 2,0 mm

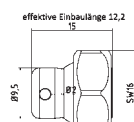

### 1-DU-90-1

Düse 90° Bohrung 1 x Ø 2 mm  
nozzle 90° drill hole 1 x Ø 2 mm

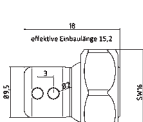
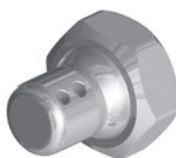

### 1-DU-90-2

Düse 90° Bohrung 2 x Ø 2 mm  
nozzle 90° drill hole 2 x Ø 2 mm

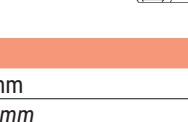
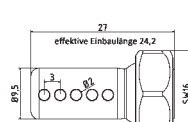

### 1-DU-90-5

Düse 90° Bohrung 5 x Ø 2 mm  
nozzle 90° drill hole 5 x Ø 2 mm

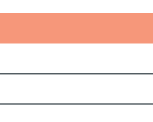
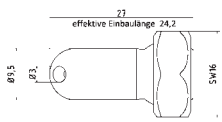

### 1-DU-30

Düse 30° Bohrung Ø 3 mm  
nozzle 30° drill hole Ø 3 mm

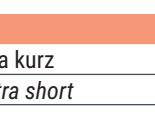
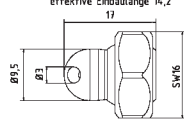
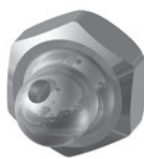

### 1-DU-30-EK

Düse 30° Bohrung Ø 3 mm extra kurz  
nozzle 30° drill hole Ø 3 mm extra short

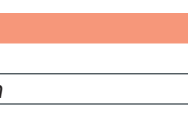
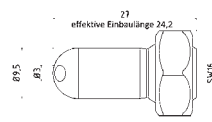

### 1-DU-60

Düse 60° Bohrung Ø 3 mm  
nozzle 60° drill hole Ø 3 mm

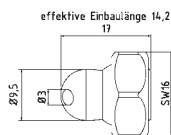
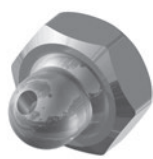

### 1-DU-60-EK

Düse 60° Bohrung Ø 3 mm extra kurz  
nozzle 60° drill hole Ø 3 mm extra short

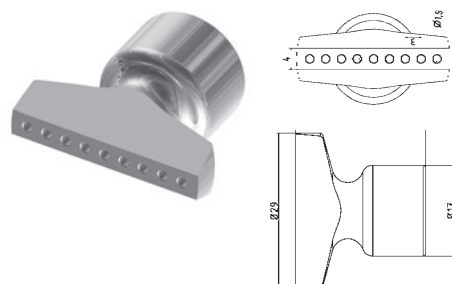

### 1-DU-BL

Düse Breit mit Bohrungen 9 x Ø 1,5 mm  
nozzle broadly with drillings 9 x Ø 1,5 mm

# Typ1 [1/4" System]

## Düsen | Nozzles

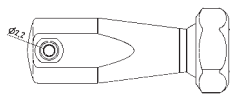
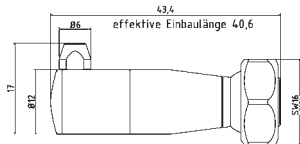
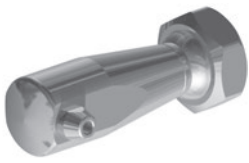

### 1-HA-DU

Halterung Düse klein I = 40 inkl. 3 Düsen  
small nozzle holder I = 40 incl. 3 nozzles

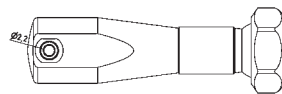
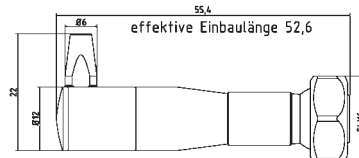
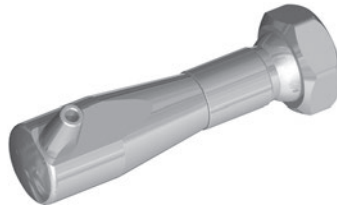

### 1-HA-DU-2

Halterung Düse klein I = 55 inkl. 3 Düsen  
small nozzle holder I = 55 incl. 3 nozzles

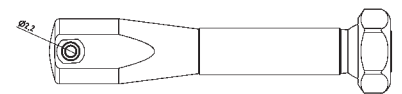
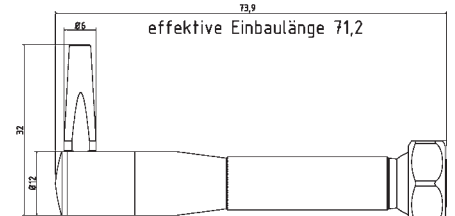
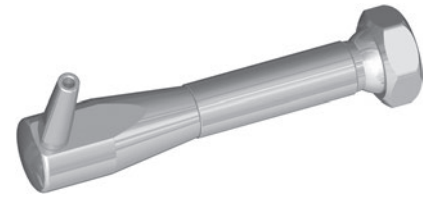

### 1-HA-DU-3

Halterung Düse klein I = 70 inkl. 3 Düsen  
small nozzle holder I = 70 incl. 3 nozzles

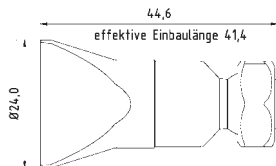
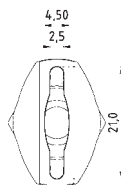

### 1-DU-SL-SS

Flachdüse Breit mit Schlitz 21 x 2,5 mm  
Streustrahl  
flat nozzle broadly with slit 21 x 2,5 mm  
scattered beam

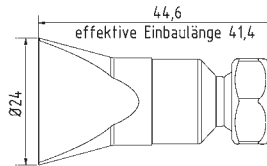
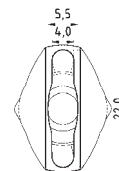

### 1-DU-SL-25

Flachdüse Breit mit Schlitz 22 x 4,0 mm  
Streustrahl zum Schwemmen  
flat nozzle broadly with slit 22 x 4,0 mm scatter-  
red beam

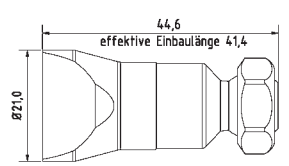
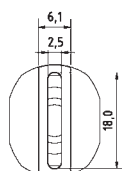
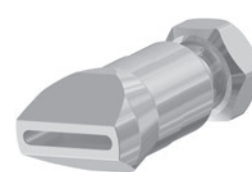

### 1-DU-SL-GS

Flachdüse Breit mit Schlitz 18 x 2,5 mm  
gerader Strahl  
flat nozzle broadly with slit 18 x 2,5 mm straight  
jet

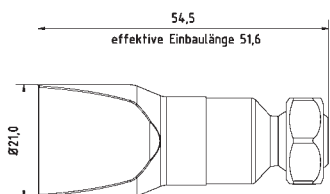
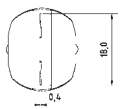
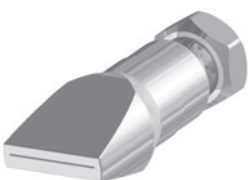

### 1-DU-SL-25-GS-0.4

Flachdüse Breit mit Schlitz 18 x 0,4 mm  
gerader Strahl  
flat nozzle broadly with slit 18 x 0,4 mm  
straight jet

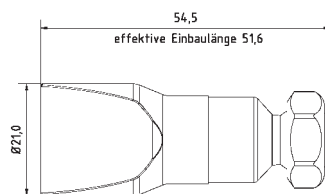
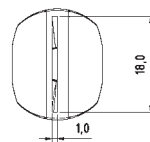
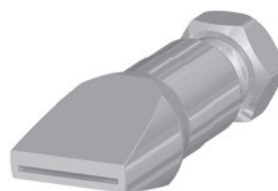

### 1-DU-SL-25-GS-1.0

Flachdüse Breit mit Schlitz 18 x 1,0 mm  
gerader Strahl  
flat nozzle broadly with slit 18 x 1,0 mm  
straight jet

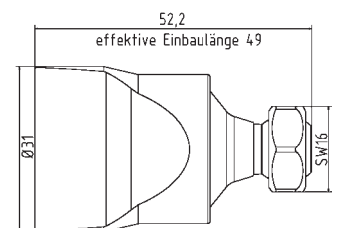
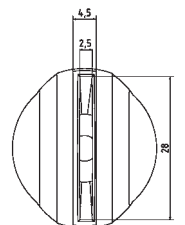

### 1-DU-SL-31-GS

Flachdüse Breit mit Schlitz 28 x 2,5 mm  
gerader Strahl  
flat nozzle broadly with slit 28 x 2,5 mm  
straight jet

**Düsen | Nozzles**

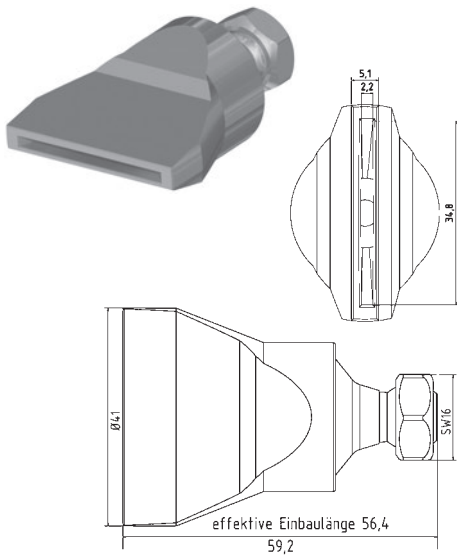

**1-DU-SL-50-GS**

Flachdüse Schlitzbreite 35 x 2,2 mm  
gerader Strahl  
*flat nozzle broadly with slit 35 x 2,2 mm  
straight jet*

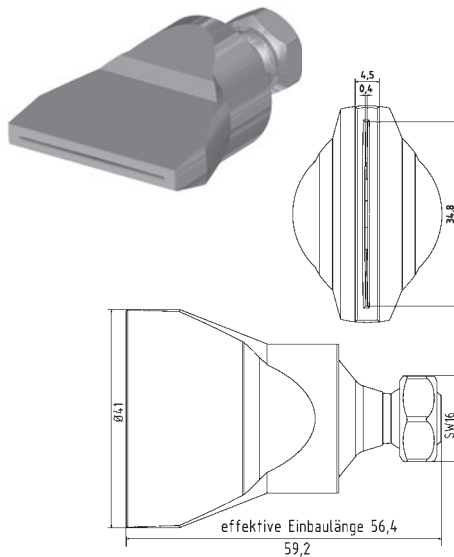

**1-DU-SL-50-GS-0.4**

Flachdüse Schlitzbreite 35 x 0,4 mm  
gerader Strahl  
*flat nozzle broadly with slit 35 x 0,4 mm  
straight jet*

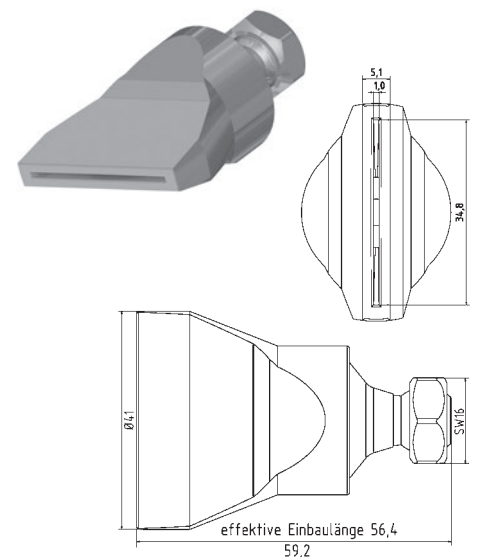

**1-DU-SL-50-GS-1.0**

Flachdüse Schlitzbreite 35 x 1,0 mm  
gerader Strahl  
*flat nozzle broadly with slit 35 x 1,0 mm  
straight jet*

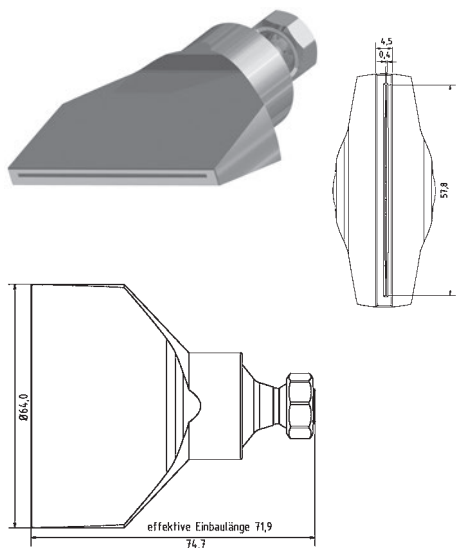

**1-DU-SL-65-GS-0.4**

Flachdüse Schlitzbreite 58 x 0,4 mm  
gerader Strahl  
*flat nozzle broadly with slit 58 x 0,4 mm  
straight jet*

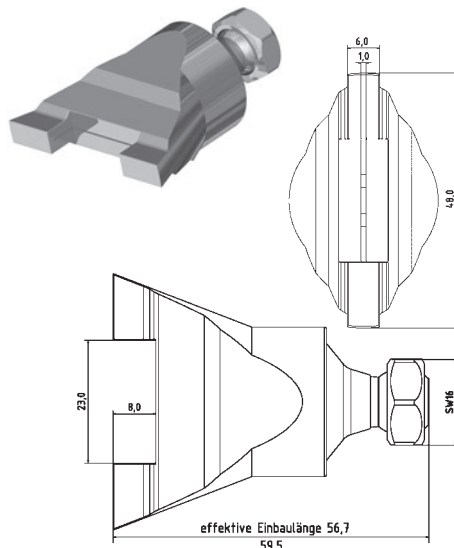

**1-DU-1912-SA**

Flachdüse Schlitzbreite 23 mm  
mit seitlicher Kühlung gerader Strahl  
*flat nozzle broadly with slit 23 mm  
with lateral cooling straight jet*

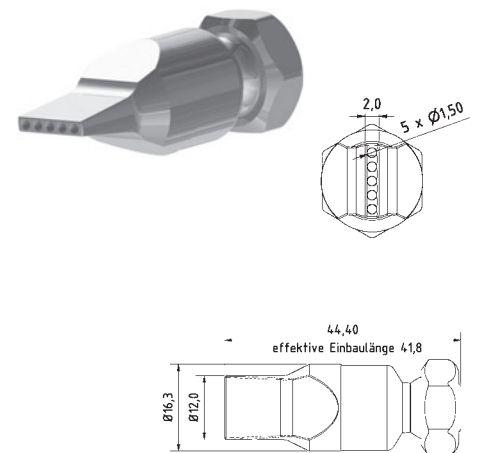

**1-DU-LL-5-15**

Düse gerade Bohrungen 5 x Ø 1,5 mm  
*nozzle straight drill hole 5 x Ø 1,5 mm*

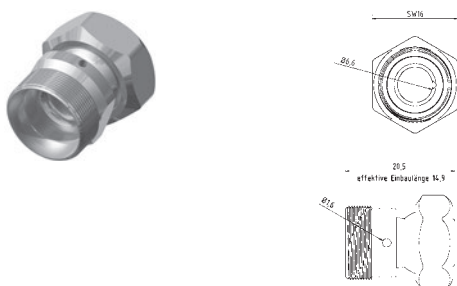

**1-DU-R**

Ringdüsen Element Bohrung Ø 1,6 mm  
*ring nozzle element drill hole Ø 1,6 mm*

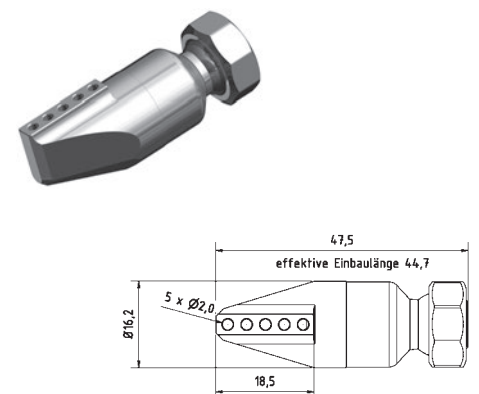

**1-DU-LL-90-5-2**

Düse 90° Bohrungen 5 x Ø 2 mm  
*nozzle 90° drill hole 5 x Ø 2 mm*

# Typ1 [1/4" System]

## Düsen und Halterungen | Nozzles and Holder

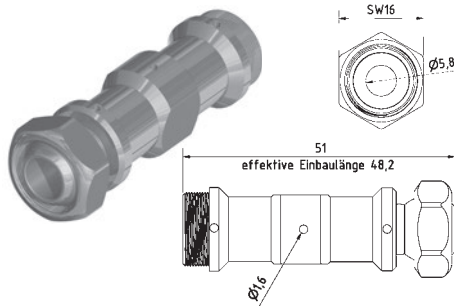

**1-DU-EL3**  
Duschelement mit Bohrungen 3 x  $\varnothing$  1,6 mm  
*shower element drillings 3 x  $\varnothing$  1,6 mm*

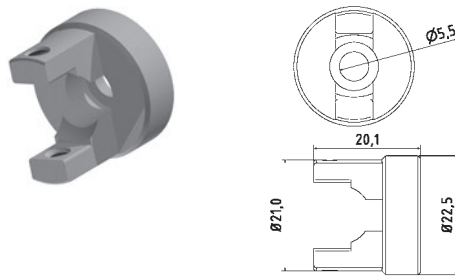

**1-DU-ELH**  
Halterung zu Duschelement (inkl. Feststellschrauben)  
*holder to shower element (incl. Screws)*

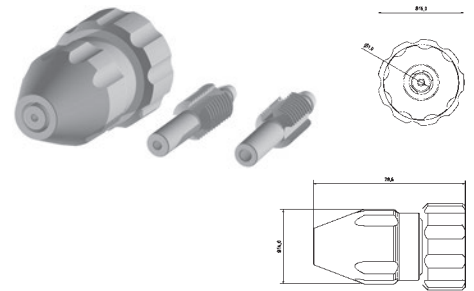

**1-DU-Mini**  
Düse Minimalmengenschmiersystem Set für 2 mm, 2,5 mm und 3 mm Schlauch  
*nozzle minimum lubrication system set for 2 mm, 2,5 mm and 3 mm pipe*

## Kunststoff-Düsen | Plastic Nozzles

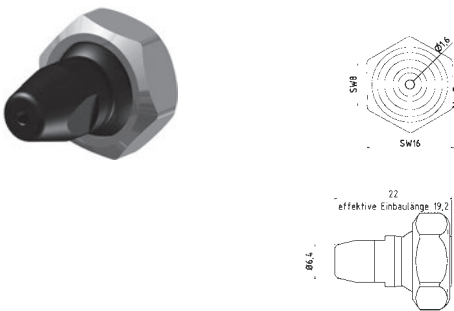

**KU-1-DU-16**  
Kunststoff-Düse gerade Bohrung  $\varnothing$  1,6 mm  
*plastic nozzle straight  $\varnothing$  1,6 mm*

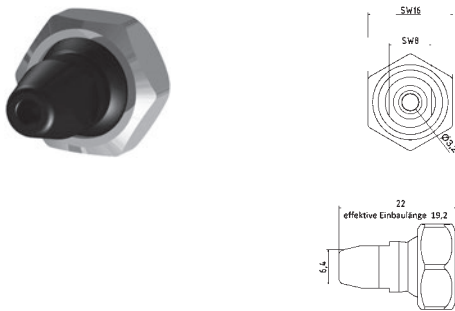

**KU-1-DU-32**  
Kunststoff-Düse gerade Bohrung  $\varnothing$  3,2 mm  
*plastic nozzle straight  $\varnothing$  3,2 mm*

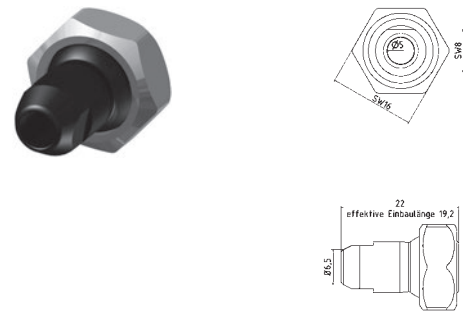

**KU-1-DU-50**  
Kunststoff-Düse gerade Bohrung  $\varnothing$  5,0 mm  
*plastic nozzle straight  $\varnothing$  5,0 mm*

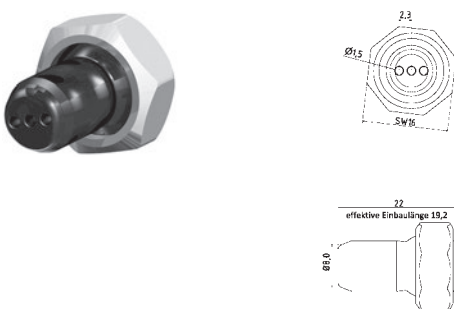

**KU-1-DU-3-16**  
Kunststoff-Düse gerade Bohrung 3 x  $\varnothing$  1,6 mm  
*plastic nozzle straight 3 x  $\varnothing$  1,6 mm*

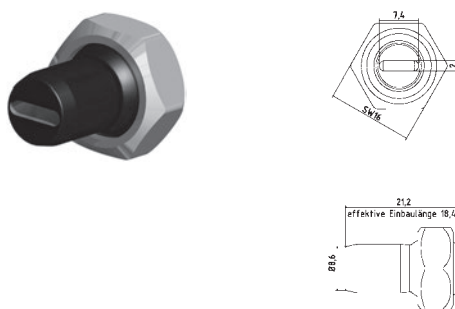

**KU-1-DU-72**  
Kunststoff-Düse mit Schlitz 7 x 2,0 mm  
*plastic nozzle straight with slit 7 x 2,0 mm*

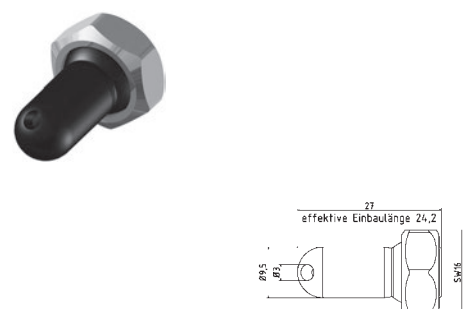

**KU-1-DU-30**  
Kunststoff-Düse 30° Bohrung  $\varnothing$  3 mm  
*plastic nozzle 30° drill hole  $\varnothing$  3 mm*

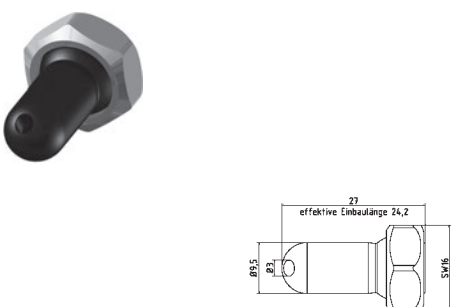

**KU-1-DU-60**  
Kunststoff-Düse 60° Bohrung  $\varnothing$  3 mm  
*plastic nozzle 60° drill hole  $\varnothing$  3 mm*

## Zubehör | Accessories

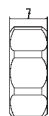

### 1-MU-HA

Mutter für Handverstellung  
*screw nut (hand feed)*

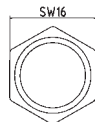
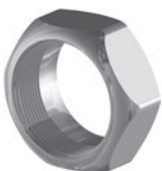
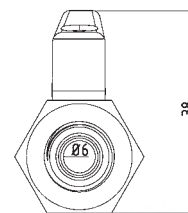
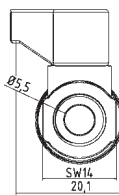

### 1-MU

Mutter Standard  
*screw nut (default)*

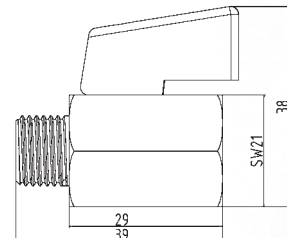
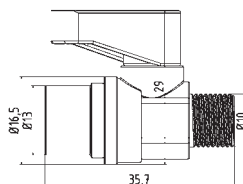

### KH-18

Mini-Kugelhahn G1/8" Messing Verchromt  
*mini ball valve thread 1/8" brass chrome-plated*

### KH-14

Mini-Kugelhahn G1/4" Messing Verchromt  
*mini ball valve thread 1/4" brass chrome-plated*

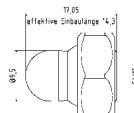
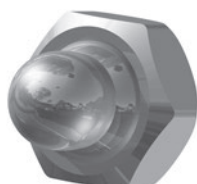

### KH-14-SS

Mini-Kugelhahn G1/4" Edelstahl  
*mini ball valve thread 1/4" stainless steel*

### 1-VK

Verschlusskappe Typ 1  
*cap type 1*

### 1-VER

Verschlussstopfen m. Mutter für Duschelement  
*seal plug with screw nut for shower element*

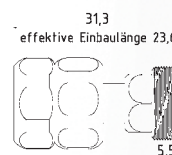
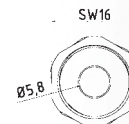

### SW-11

Schlüssel aus Stahl SW11  
*open end wrench SW11*

### SW-16

Schlüssel aus Stahl SW16  
*open end wrench SW16*

### 1-FP

Zwischenelement mit fester Position  
(Schnellkupplung)  
*Intermediate element with fixed position  
(quick coupling)*

## Grundset | Basic Set

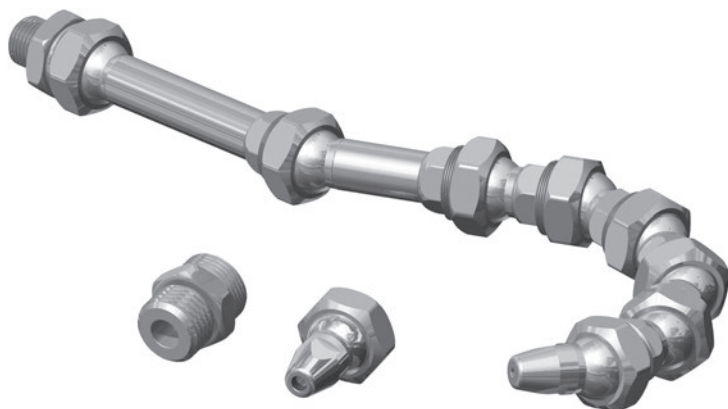

### 1-GS

Grundset Typ1 1/4" System L = 220 mm  
6 x 1-GE, 1 x 1-GE-2, 1 x 1-GE-3, 1 x 1-AD-18, 1 x 1-AD-14, 1 x 1-DU-16, 1 x 1-DU-32  
*basic set Type1 1/4" system l = 220 mm:*  
6 x 1-GE, 1 x 1-GE-2, 1 x 1-GE-3, 1 x 1-AD-18, 1 x 1-AD-14, 1 x 1-DU-16, 1 x 1-DU-32

### 1-GS-R

Ringdüsen Set (17 x 1-DU-R + 1 x 1-WV-R)  
Ø = 80 mm erweiterbar  
*ring nozzle set (17 x 1-DU-R + 1 x 1-WV-R)*  
Ø = 80 mm expendable



# PRODUKTÜBERSICHT

## Typ2 [1/2"]



Mit dem Typ2 System optimieren Sie Ihren Maschinenprozess um  $\pm 12\%$ . Nutzen Sie die Vielfalt des Düsen Sortiments und passen Sie die Kühlung an Ihre Bedürfnisse an. Ob Flachdüsen, Runddüsen oder Düsen mit mehreren Auslässen, zum Schleifen, Drehen, Fräsen oder der Luftkühlung, finden Sie hier die passenden Elemente. Die Typ2 Grundelemente und Maschinenadapter sorgen für ein Rundes Sortiment, welches Ihnen die Sicherheit bietet, Werkzeugverschleiß zu optimieren und garantieren für eine stabile Kühlung.

**TECHNISCHE DATEN:**

- Größe Typ2 (1/2")
- Durchlass Ø 11,0 mm
- Druckbeständig über 100 bar
- Einsatzbereich -30°C bis +60°C
- Optional ES-System bis +300°C (auf Anfrage erhältlich)
- Gewinde (Elemente) M24x1
- Material 1.4305 (V2A)

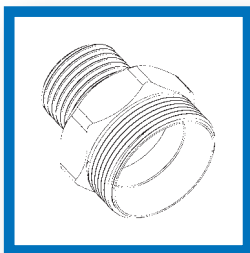
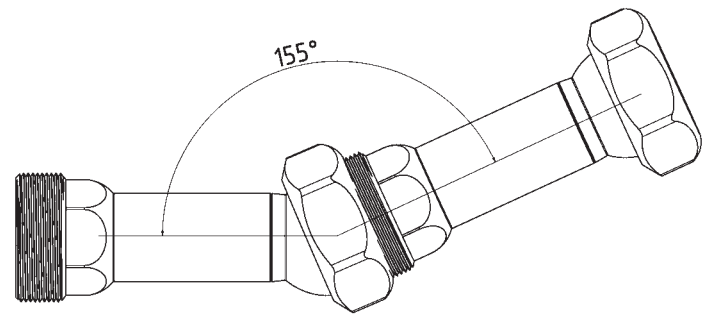
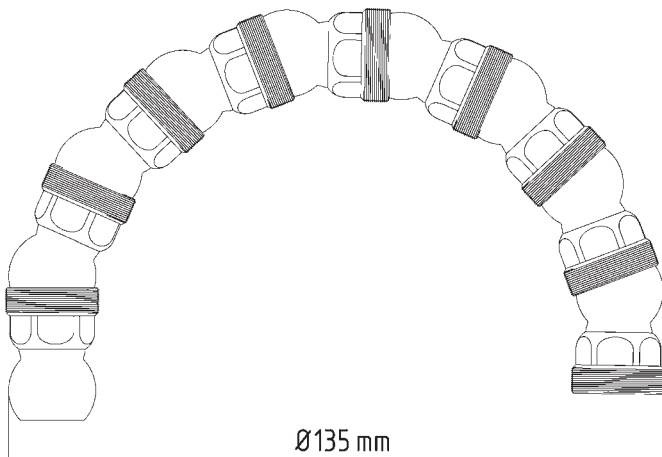

MASCHINENADAPTER

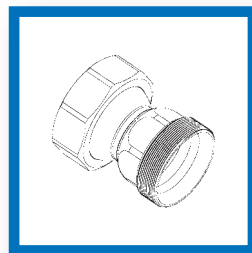

GRUNDELEMENTE

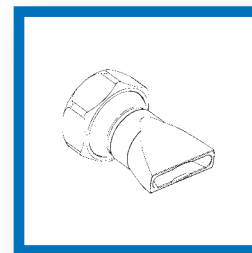

DÜSEN

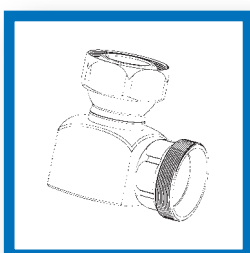

WINKELELEMENTE

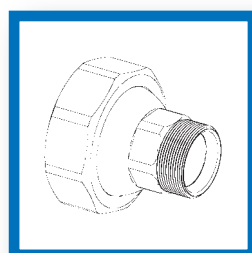

ZUBEHÖR

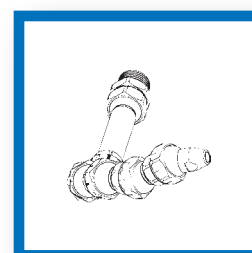

GRUNDSET Typ2

# Typ2 [1/2" System]

## Grundelemente | Basic Elements

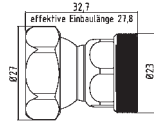
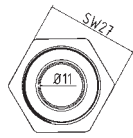

### 2-GE

$l = 32,7$  mm effektiv  $l = 27,8$  mm  
 $l = 32,7$  mm effective  $l = 27,8$  mm

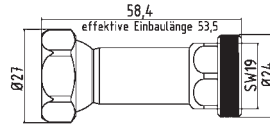
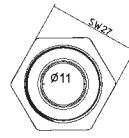

### 2-GE-2

$l = 58,4$  mm effektiv  $l = 53,5$  mm  
 $l = 58,4$  mm effective  $l = 53,5$  mm

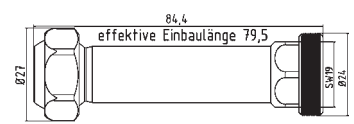
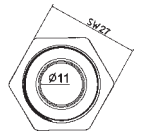

### 2-GE-3

$l = 84,4$  mm effektiv  $l = 79,5$  mm  
 $l = 84,4$  mm effective  $l = 79,5$  mm

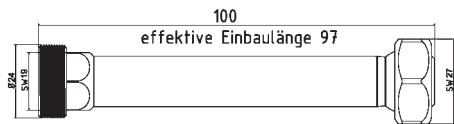
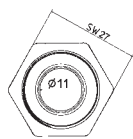

### 2-GE-100

$l = 100$  mm effektiv  $l = 97$  mm  
 $l = 100$  mm effective  $l = 97$  mm

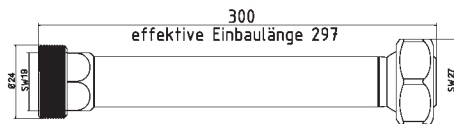
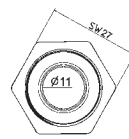

### 2-GE-300

$l = 300$  mm effektiv  $l = 297$  mm  
 $l = 300$  mm effective  $l = 297$  mm

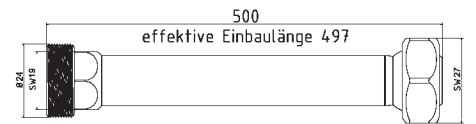
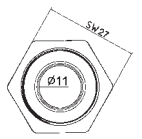

### 2-GE-500

$l = 500$  mm effektiv  $l = 497$  mm  
 $l = 500$  mm effective  $l = 497$  mm

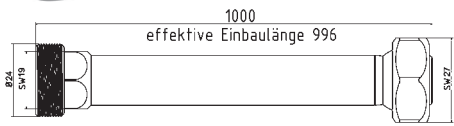
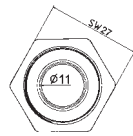

### 2-GE-1000

$l = 1000$  mm effektiv  $l = 996$  mm  
 $l = 1000$  mm effective  $l = 996$  mm

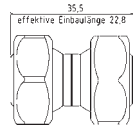
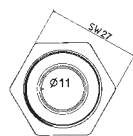

### 2-GE-DK

$l = 35,5$  mm effektiv  $l = 22,8$  mm Doppelkugel  
 $l = 35,5$  mm effective  $l = 22,8$  mm double ball

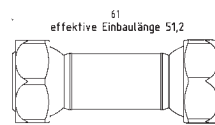
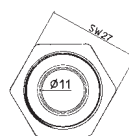
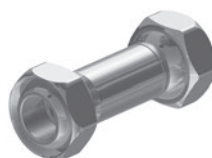

### 2-GE-2-DK

$l = 61$  mm effektiv  $l = 51,2$  mm Doppelkugel  
 $l = 61$  mm effective  $l = 51,2$  mm double ball

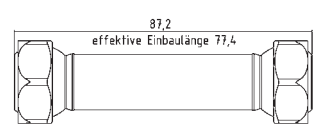
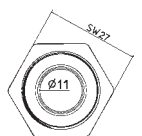

### 2-GE-3-DK

$l = 87,2$  mm effektiv  $l = 77,4$  mm Doppelkugel  
 $l = 87,2$  mm effective  $l = 77,4$  mm double ball

**Maschinen-/Düsenadapter | Machine-/Nozzle Adapter**

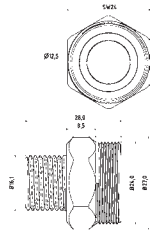
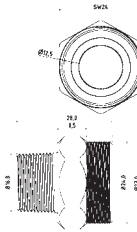
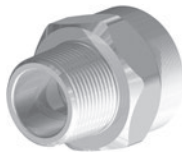
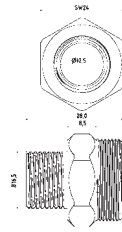

**2-AD-38**

Adapterstück G 3/8"  
adaptor piece thread 3/8"

**2-AD-38-PT**

Adapterstück G 3/8" PT (Withworth-Gewinde)  
adaptor piece thread 3/8" PT (NPT thread)

**2-AD-38-U**

Adapterstück G 3/8" U (Gewinde unterschritten)  
adaptor piece thread 3/8" U (Undercut thread)

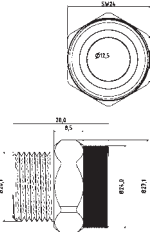
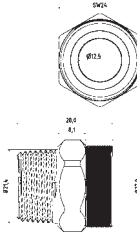
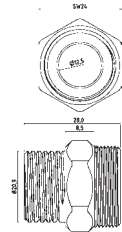

**2-AD-12**

Adapterstück G 1/2"  
adaptor piece thread 1/2"

**2-AD-12-PT**

Adapterstück G 1/2" PT (Withworth-Gewinde)  
adaptor piece thread 1/2" PT (NPT thread)

**2-AD-12-U**

Adapterstück G 1/2" U (Gewinde unterschritten)  
adaptor piece thread 1/2" U (Undercut thread)

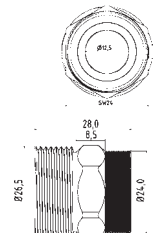
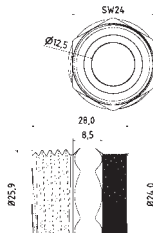
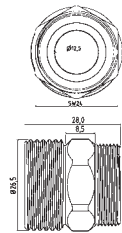

**2-AD-34**

Adapterstück G 3/4"  
adaptor piece thread 3/4"

**2-AD-34-PT**

Adapterstück G 3/4" PT (Withworth-Gewinde)  
adaptor piece thread 3/4" PT (NPT thread)

**2-AD-34-U**

Adapterstück G 3/4" U (Gewinde unterschritten)  
adaptor piece thread 3/4" U (Undercut thread)

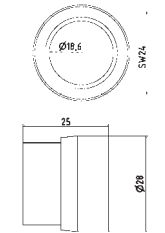
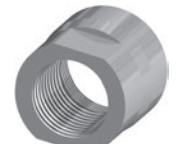
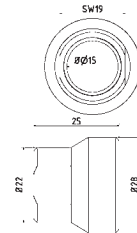
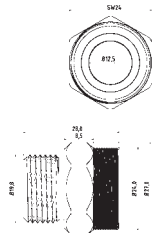

**2-AD-201.5**

Adapterstück M20 x 1.5"  
adaptor piece thread M20 x 1.5"

**2-AD-2GE-38**

Adapterstück für Fremddüsen mit  
Außengewinde, IG 2-GE auf IG 3/8"  
adapter piece for external nozzles with  
male thread, female 2-GE to female 3/8"

**2-AD-2GE-12**

Adapterstück für Fremddüsen mit  
Außengewinde, IG 2-GE auf IG 1/2"  
adapter piece for external nozzles with  
male thread, female 2-GE to female 1/2"

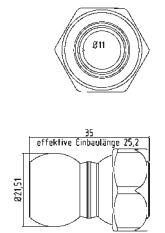
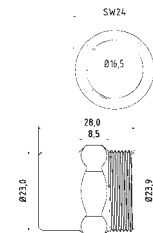
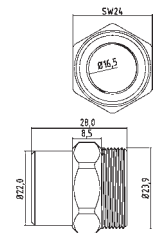

**2-AD-I161.5-Typ2**

Adapterstück M16 x 1.5 Innengewinde auf  
Hirt-Line Typ2 Aussengewinde  
adaptor piece M16 x 1.5 female thread  
to Hirt-Line type2 male thread

**2-AD-I181.5-Typ2**

Adapterstück M18 x 1.5 Innengewinde auf  
Hirt-Line Typ2 Aussengewinde  
adaptor piece M18 x 1.5 female thread  
to Hirt-Line type2 male thread

**2-AD-LL**

Adapterstück Loc-Line Typ 2  
adaptor piece Loc-Line Type 2

# Typ2 [1/2" System]

## Winklelemente | Elbows

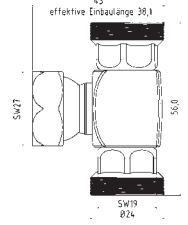
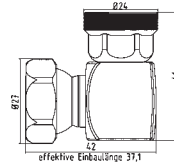
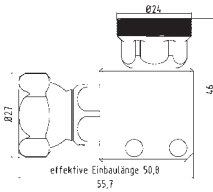
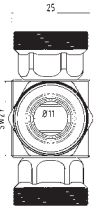
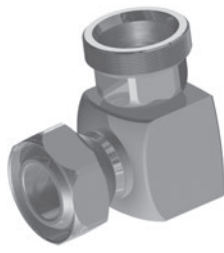
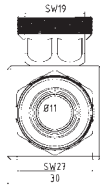
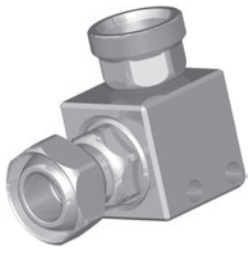

**2-WI**  
Winkelstück für Leitungen mit 2 Bohrungen  
*corner piece for pipelines with 2 bore hole*

**2-WV-1K**  
Winkelstück  
*elbow piece*

**2-WV-2K**  
T-Stück  
*T-piece*

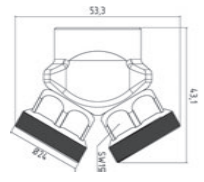
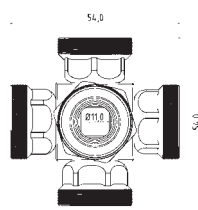
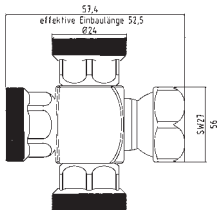
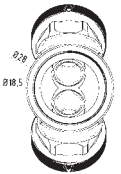
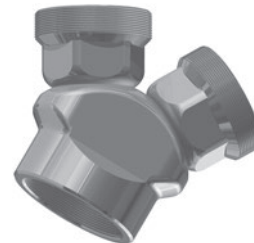
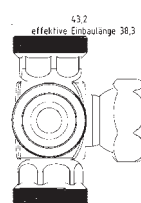
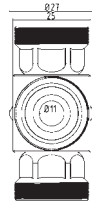
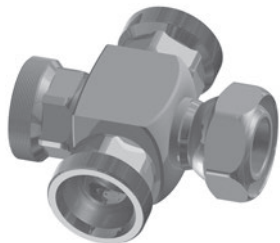

**2-WV-3K**  
Kreuz-Stück  
*cross piece*

**2-WV-4K**  
Stern-Stück  
*star piece*

**2-YV**  
Y-Stück 50°  
*Y-piece 50°*

## Düsen | Nozzles

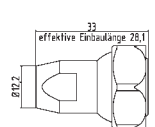
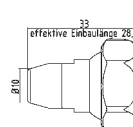
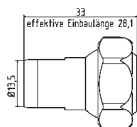
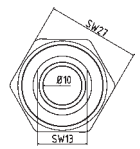
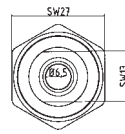
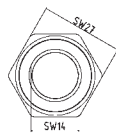
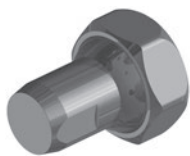

**2-DU-0**  
Düse ohne Bohrung (für Spezialanwendungen)  
*nozzle without hole (for special applications)*

**2-DU-65**  
Düse gerade Bohrung Ø 6,5 mm  
*nozzle straight Ø 6,5 mm*

**2-DU-10**  
Düse gerade Bohrung Ø 10 mm  
*nozzle straight Ø 10 mm*

**Düsen | Nozzles**

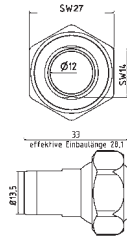

**2-DU-12**

Düse gerade Bohrung Ø 12 mm  
nozzle straight Ø 12 mm

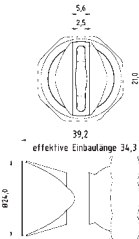

**2-DU-SL-25-SS**

Flachdüse Schlitzbreite 20 x 2,5 mm  
Streustrahl  
flat nozzle broadly with slit 20 x 2,5 mm  
scattered beam

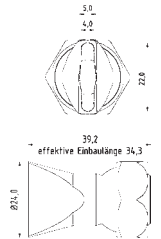

**2-DU-SL-25**

Flachdüse Schlitzbreite 22 x 4,0 mm  
Streustrahl  
flat nozzle broadly with slit 22 x 4,0 mm  
scattered beam

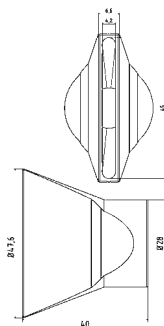
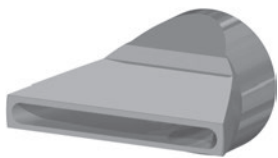

**2-DU-SL-50**

Flachdüse Schlitzbreite 45 x 4,2 mm  
Streustrahl  
flat nozzle broadly with slit 45 x 4,2 mm  
scattered beam

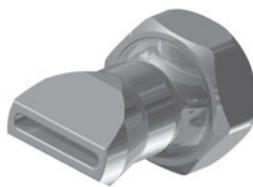

**2-DU-SL-25-GS**

Flachdüse Schlitzbreite 18 x 2,5 mm  
gerader Strahl  
flat nozzle broadly with slit 18 x 2,5 mm  
straight jet

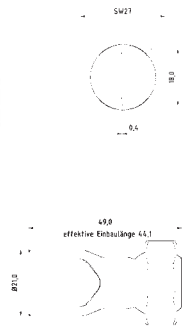
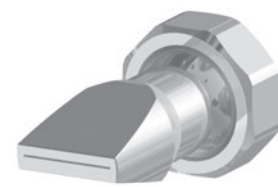

**2-DU-SL-25-GS-0.4**

Flachdüse Schlitzbreite 18 x 0,4 mm  
gerader Strahl  
flat nozzle broadly with slit 18 x 0,4 mm  
straight jet

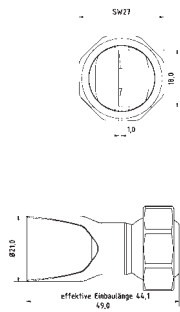

**2-DU-SL-25-GS-1.0**

Flachdüse Schlitzbreite 18 x 1,0 mm  
gerader Strahl  
flat nozzle broadly with slit 18 x 1,0 mm  
straight jet

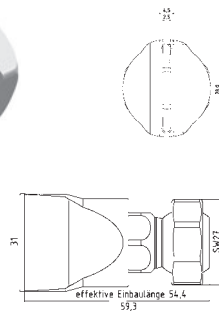
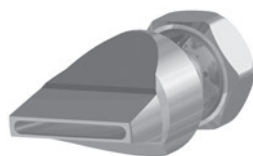

**2-DU-SL-31-GS**

Flachdüse Schlitzbreite 28 x 2,5 mm  
gerader Strahl  
flat nozzle broadly with slit 28 x 2,5 mm  
straight jet

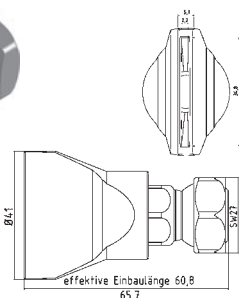
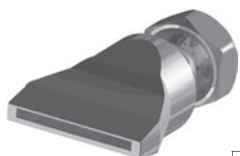

**2-DU-SL-50-GS**

Flachdüse Schlitzbreite 35 x 2,2 mm  
gerader Strahl  
flat nozzle broadly with slit 35 x 2,2 mm  
straight jet

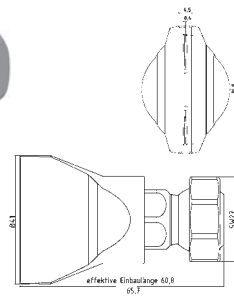
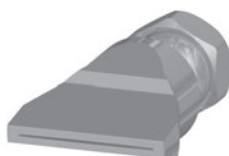

**2-DU-SL-50-GS-0.4**

Flachdüse Schlitzbreite 35 x 0,4 mm  
gerader Strahl  
flat nozzle broadly with slit 35 x 0,4 mm  
straight jet

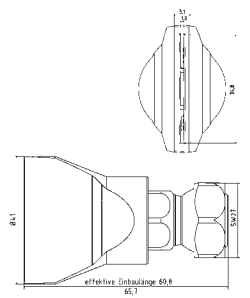
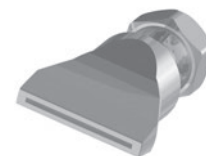

**2-DU-SL-50-GS-1.0**

Flachdüse Schlitzbreite 35 x 1,0 mm  
gerader Strahl  
flat nozzle broadly with slit 35 x 1,0 mm  
straight jet

# Typ2 [1/2" System]

## Düsen | Nozzles

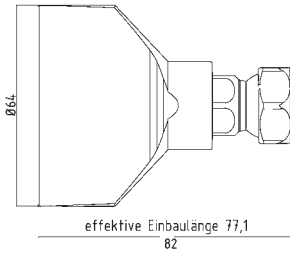
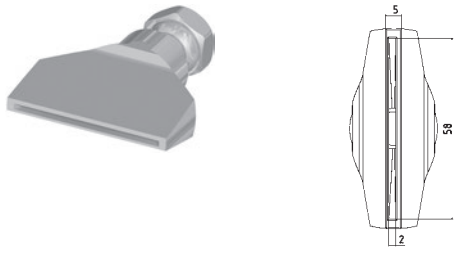

### 2-DU-SL-65-GS

Flachdüse Schlitzbreite 58 x 2,0 mm  
gerader Strahl  
*flat nozzle broadly with slit 58 x 2,0 mm  
straight jet*

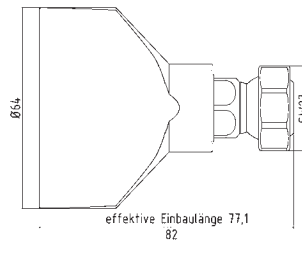
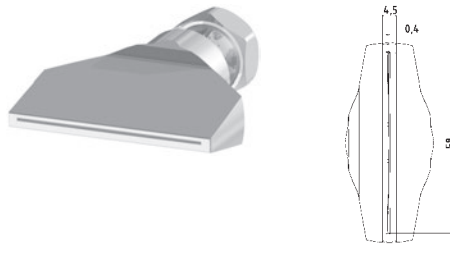

### 2-DU-SL-65-GS-0.4

Flachdüse Schlitzbreite 58 x 0,4 mm  
gerader Strahl  
*flat nozzle broadly with slit 58 x 0,4 mm  
straight jet*

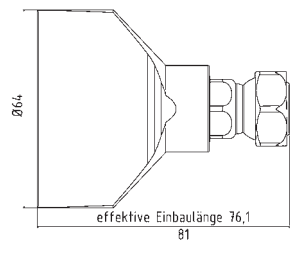
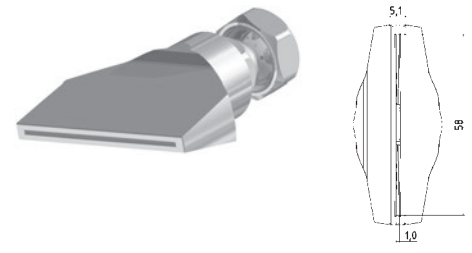

### 2-DU-SL-65-GS-1.0

Flachdüse Schlitzbreite 58 x 1,0 mm  
gerader Strahl  
*flat nozzle broadly with slit 58 x 1,0 mm  
straight jet*

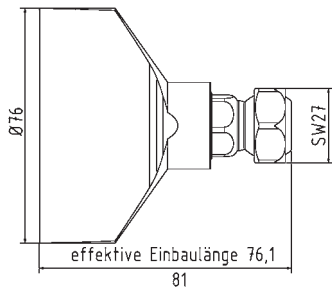
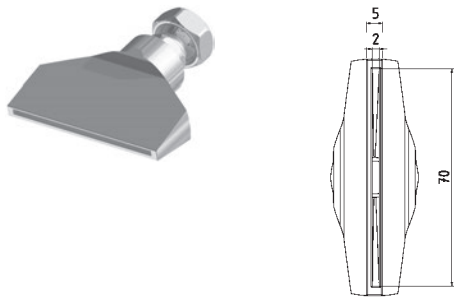

### 2-DU-SL-76-GS

Flachdüse Schlitzbreite 70 x 2,0 mm  
gerader Strahl  
*flat nozzle broadly with slit 70 x 2,0 mm  
straight jet*

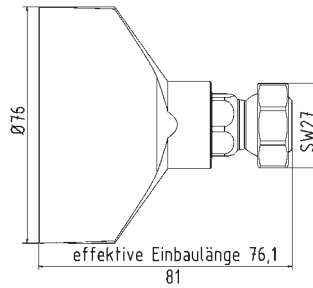
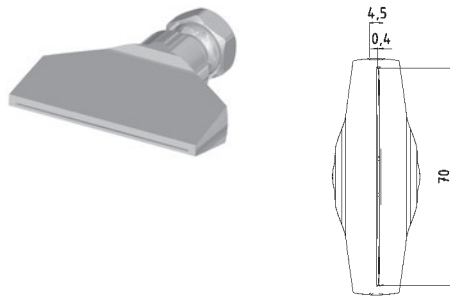

### 2-DU-SL-76-GS-0.4

Flachdüse Schlitzbreite 70 x 0,4 mm  
gerader Strahl  
*flat nozzle broadly with slit 70 x 0,4 mm  
straight jet*

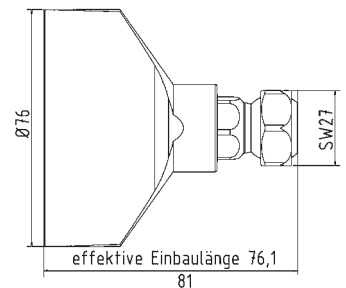
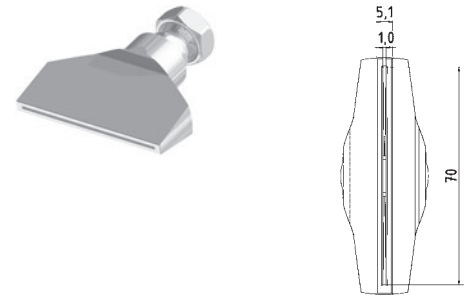

### 2-DU-SL-76-GS-1.0

Flachdüse Schlitzbreite 70 x 1,0 mm  
gerader Strahl  
*flat nozzle broadly with slit 70 x 1,0 mm  
straight jet*

Düsen | Nozzles

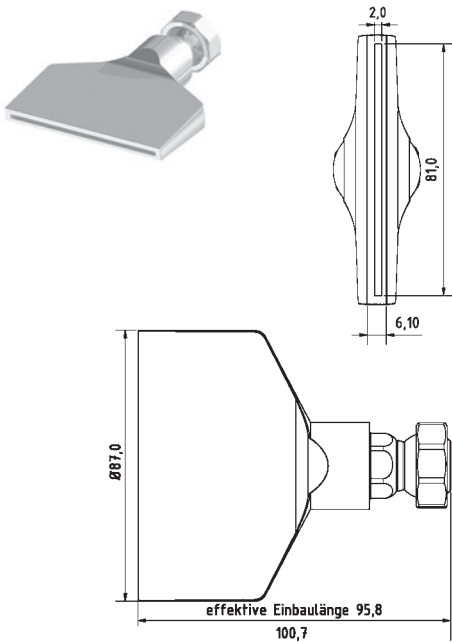

**2-DU-SL-87-GS**

Flachdüse Schlitzbreite 81 x 2,0 mm  
gerader Strahl  
*flat nozzle broadly with slit 81 x 2,0 mm  
straight jet*

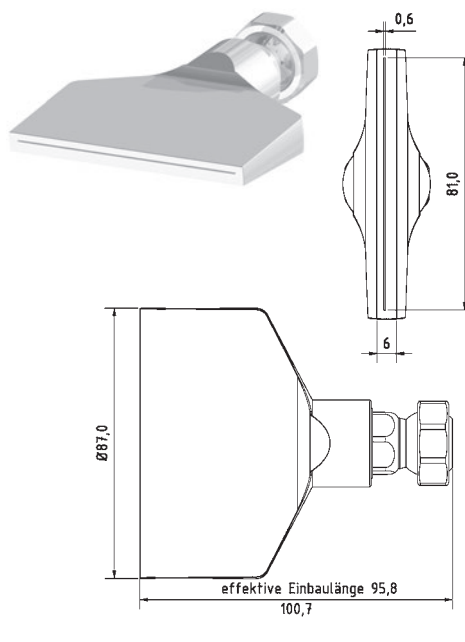

**2-DU-SL-87-GS-0.6**

Flachdüse Schlitzbreite 81 x 0,6 mm  
gerader Strahl  
*flat nozzle broadly with slit 81 x 0,6 mm  
straight jet*

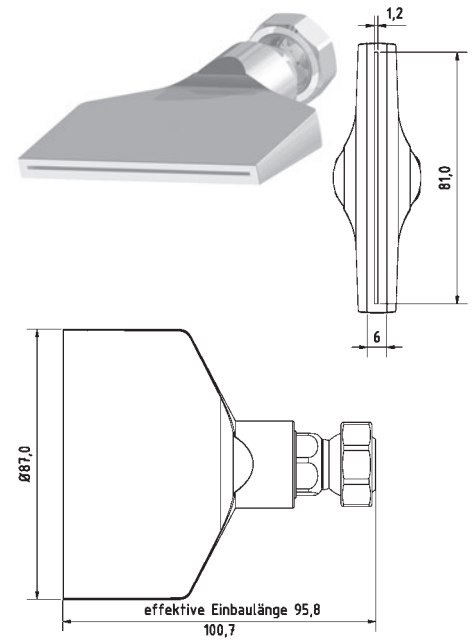

**2-DU-SL-87-GS-1.2**

Flachdüse Schlitzbreite 81 x 1,2 mm  
gerader Strahl  
*flat nozzle broadly with slit 81 x 1,2 mm  
straight jet*

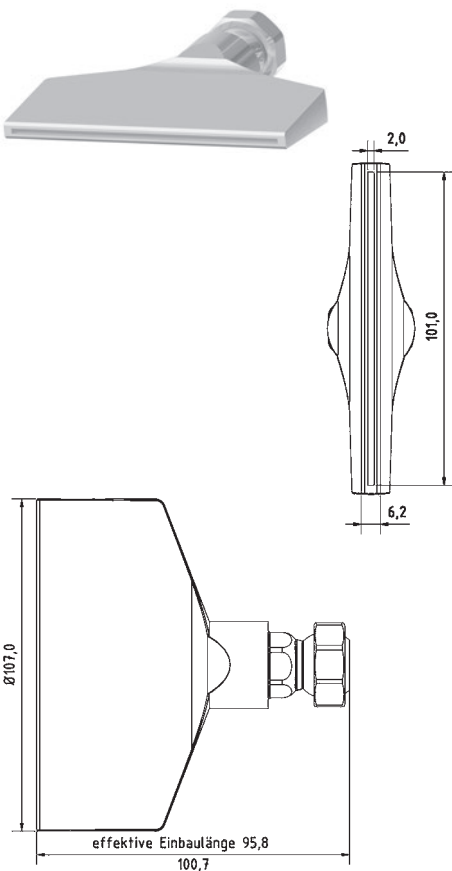

**2-DU-SL-107-GS**

Flachdüse Schlitzbreite 101 x 2,0 mm  
gerader Strahl  
*flat nozzle broadly with slit 101 x 2,0 mm  
straight jet*

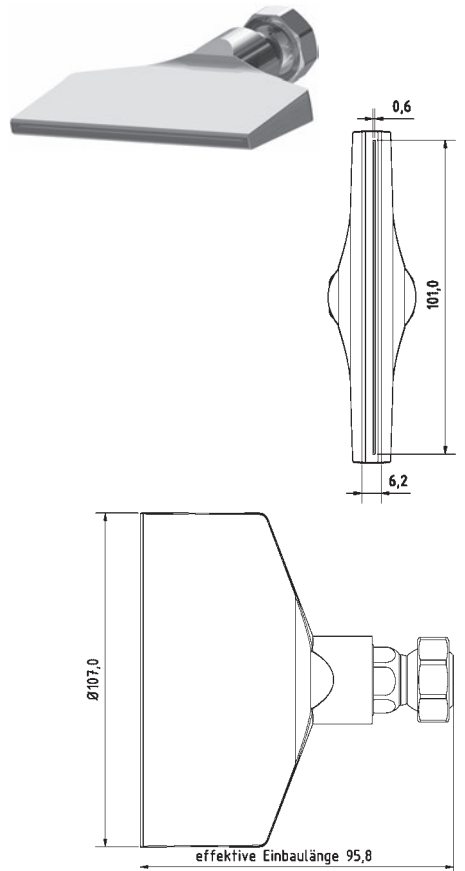

**2-DU-SL-107-GS-0.6**

Flachdüse Schlitzbreite 101 x 0,6 mm  
gerader Strahl  
*flat nozzle broadly with slit 101 x 0,6 mm  
straight jet*

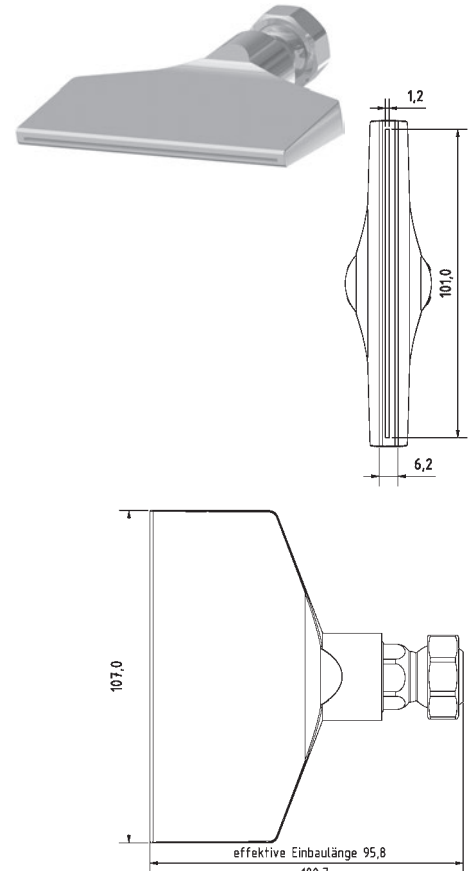

**2-DU-SL-107-GS-1.2**

Flachdüse Schlitzbreite 101 x 1,2 mm  
gerader Strahl  
*flat nozzle broadly with slit 101 x 1,2 mm  
straight jet*



# Typ2 [1/2" System]

## Düsen | Nozzles

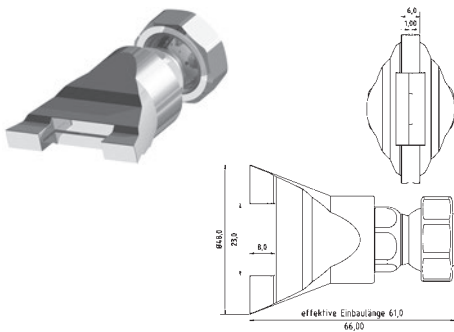

### 2-DU-1912-SA

Flachdüse Schlitzbreite 23 mm mit seitlicher Kühlung gerader Strahl  
*flat nozzle broadly with slit 23 mm with lateral cooling straight jet*

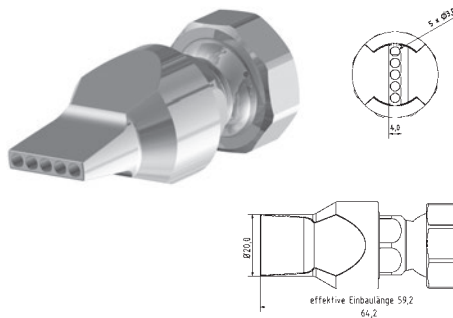

### 2-DU-LL-5-3

Düse gerade Bohrungen 5 x Ø 3 mm  
*nozzle straight drill holes 5 x Ø 3 mm*

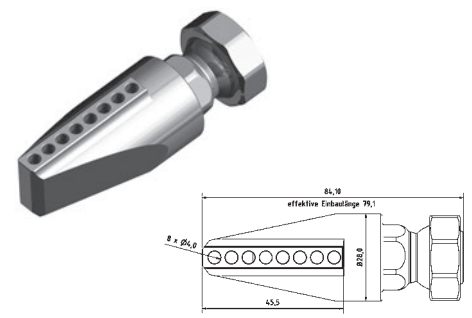

### 2-DU-LL-90-8

Düse 90° Bohrungen 8 x Ø 4 mm  
*nozzle 90° drill holes 8 x Ø 4 mm*

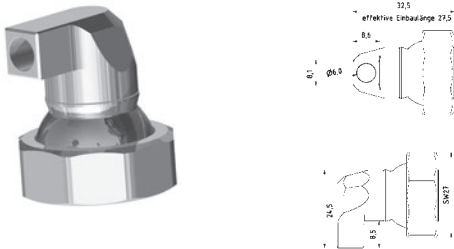

### 2-DU-LL-90-1-6

Düse 90° Bohrung 1 x Ø 6 mm  
*nozzle 90° drill hole 1 x Ø 6 mm*

## Kunststoff-Düsen | Plastic Nozzles



### KU-2-DU-65

Kunststoff-Düse gerade Bohrung Ø 6,5 mm  
*plastic nozzle straight Ø 6,5 mm*

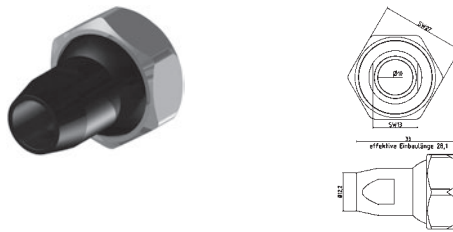

### KU-2-DU-10

Kunststoff-Düse gerade Bohrung Ø 10 mm  
*plastic nozzle straight Ø 10 mm*



### KU-2-DU-12

Kunststoff-Düse gerade Bohrung Ø 12 mm  
*plastic nozzle straight Ø 12 mm*

## Zubehör | Accessories

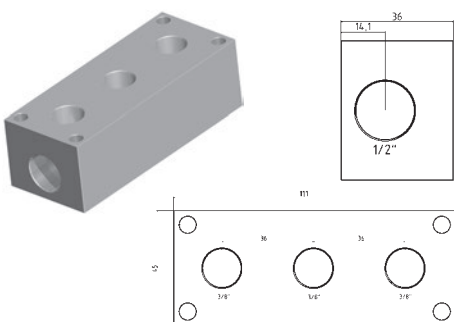

### VB-3-38

Verteilerblock Eingang Stirnseite G1/2"  
*manifold block entrance front end 1/2"*

### VB-3-38-PT

Verteilerblock Eingang Stirnseite G1/2" PT  
*manifold block entrance front end 1/2" NPT*



### VB-3-38-BS

Blindstopfen G3/8"  
*blank plug with thread 3/8"*

### VB-3-38-PT-BS

Blindstopfen mit G3/8" PT Gewinde  
*blank plug with thread 3/8" NPT*

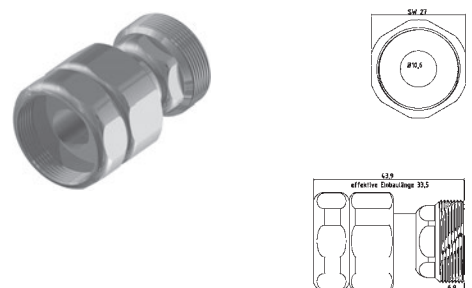

### 2-FP

Zwischenelement mit fester Position  
 (Schnellkupplung)  
*Intermediate element with fixed position (quick coupling)*

## Zubehör | Accessories

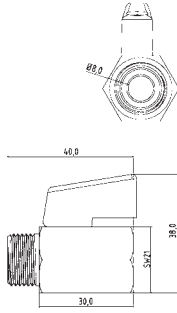

### KH-38

Mini-Kugelhahn G3/8" Messing Verchromt  
mini ball valve thread 3/8" brass chrome-plated

### KH-38-SS

Mini-Kugelhahn G3/8" Edelstahl  
mini ball valve thread 3/8" stainless steel

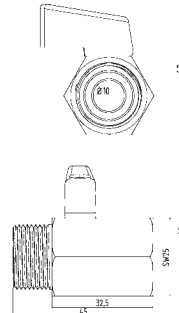

### KH-12

Mini-Kugelhahn G1/2" Messing Verchromt  
mini ball valve thread 1/2" brass chrome-plated

### KH-12-SS

Mini-Kugelhahn G1/2" Edelstahl  
mini ball valve thread 1/2" stainless steel

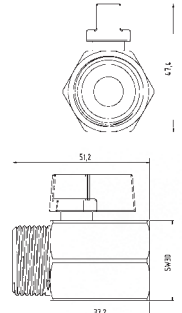

### KH-34

Mini-Kugelhahn G3/4" Messing Verchromt  
mini ball valve thread 3/4"

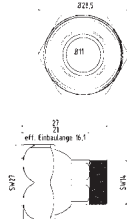

### RE-2-1

Reduktion Typ 2 auf Typ 1  
reduction Type 2 to Type 1

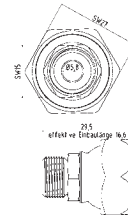

### RE-2-G1/4

Reduktion Typ 2 auf G 1/4"  
reduction Type 2 to G 1/4"

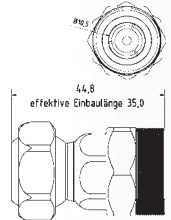

### 2-RSV

Rückschlagventil (Drop-Stop)  
Check valve (Drop-Stop)

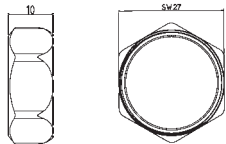

### 2-MU

Mutter Standard  
screw nut (default)

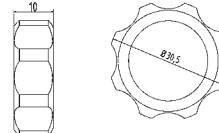
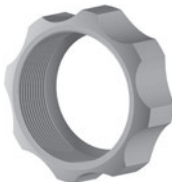

### 2-MU-HA

Mutter für Handverstellung  
screw nut (hand feed)

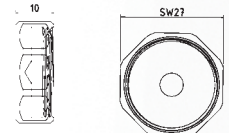
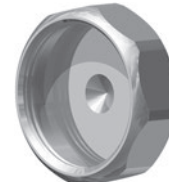

### 2-VK

Verschlusskappe Typ 2  
cap type 2



### SW-19

Schlüssel aus Stahl SW19  
open end wrench SW19



### SW-27

Schlüssel aus Stahl SW27  
open end wrench SW27

## Grundset | Basic Set

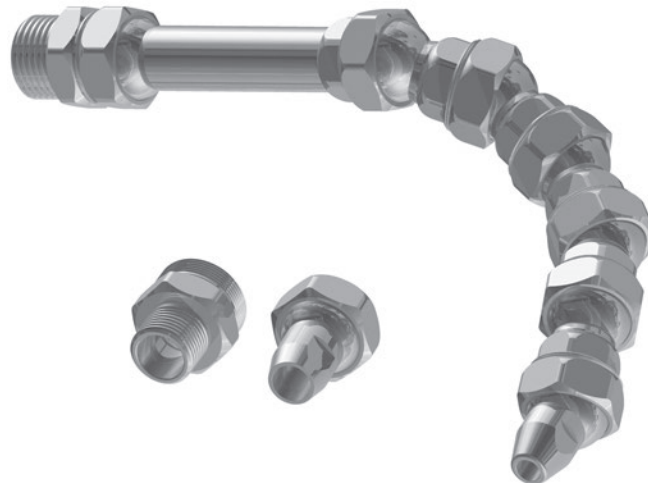

### 2-GS

Grundset Typ2 1/2" System L = 240 mm  
5 x 2-GE, 1 x 2-GE-3, 1 x 2-AD-38, 1 x 2-AD-12, 1 x 2-DU-65 1 x 2-DU-10, 1 x SW-19, 1 x SW-27  
basic set Type2 1/2" system l = 240 mm  
5 x 2-GE, 1 x 2-GE-3, 1 x 2-AD-38, 1 x 2-AD-12, 1 x 2-DU-65 1 x 2-DU-10, 1 x SW-19, 1 x SW-27

# PRODUKTÜBERSICHT

## Typ3 [3/4"]



Das System Typ3 oder auch 3/4" genannt, verspricht neben der bewährten und zuverlässigen Qualität die passende Stabilität für Ihre Maschinen. Der Durchlass mit Ø19 mm bringt die nötige Literleistung (über 200l/Min) präzise und stabil (bis 60 bar) von der Pumpe bis zum Werkzeug. Passend in diesem System gibt es aktuell 25 verschiedene Düsen, von einfachen Runddüsen ab Ø12 mm, Ø15 mm und Ø19 mm bis hin zur größten Flachdüse 101 mm x 2 mm welche auch für den Schleifprozess optimiert sind. Alle Düsen werden

in einer hohen Präzision gefertigt und sind für jede Anwendung einfach auswechselbar. Mit den Adapter 3/8", 3/4" und 1" ist es ein Leichtes, dieses System an jeder Maschine zu installieren. Wie gewohnt gibt es verschiedene Grund- und Winkelemente, welche es erlauben, das System flexibel und nach Wünschen zu konfigurieren. Optional kann ein Kugelhahn und weiteres Zubehör erworben werden.

**TECHNISCHE DATEN:**

- Größe Typ3 (3/4")
- Durchlass  $\varnothing$  19,0 mm
- Druckbeständig bis 60 bar
- Einsatzbereich -30°C bis +60°C
- Optional ES-System bis +300°C (auf Anfrage erhältlich)
- Gewinde (Elemente) M34x1
- Material 1.4305 (V2A)

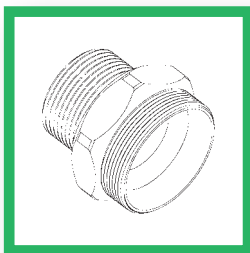
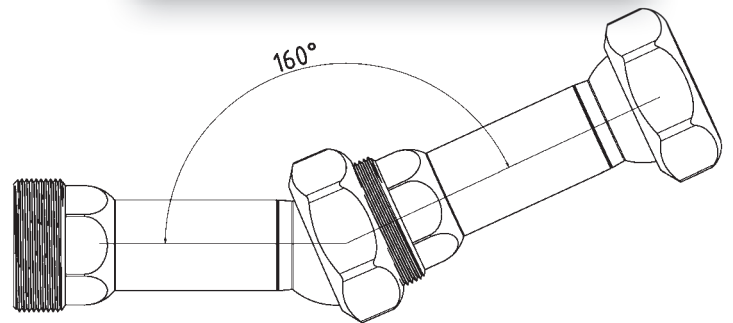
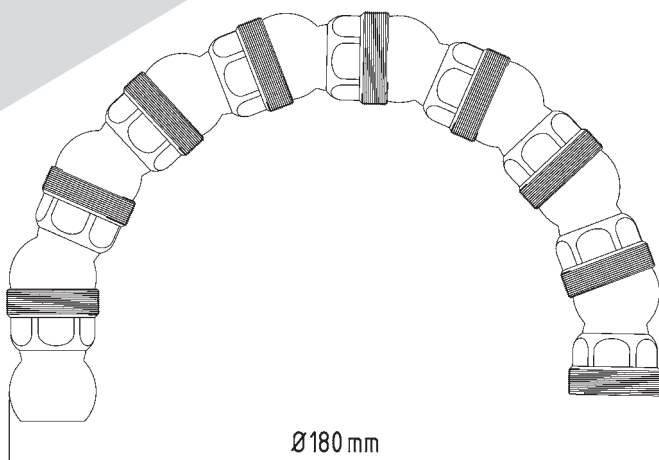

MASCHINENADAPTER

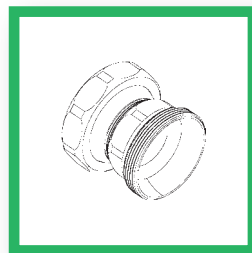

GRUNDELEMENTE

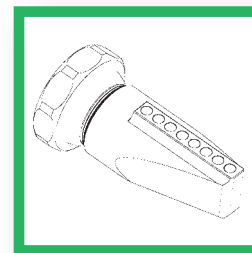

DÜSEN

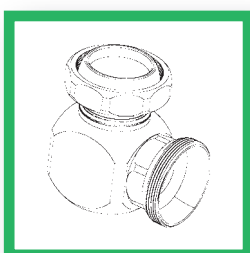

WINKELELEMENTE

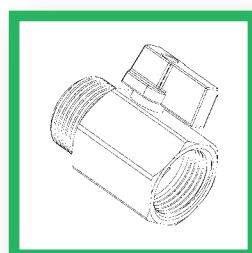

ZUBEHÖR

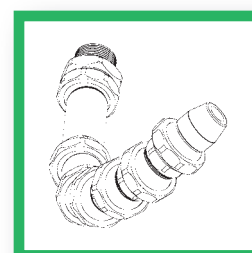

GRUNDSET Typ3

# Typ3 [3/4" System]

## Grundelemente | Basic Elements

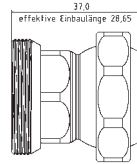
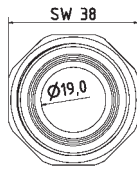

### 3-GE

$l = 37$  mm effektiv  $l = 28,6$  mm  
 $l = 37$  mm effective  $l = 28,6$  mm

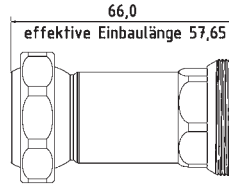
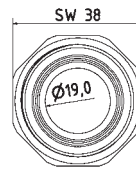

### 3-GE-2

$l = 66$  mm effektiv  $l = 57,6$  mm  
 $l = 66$  mm effective  $l = 57,6$  mm

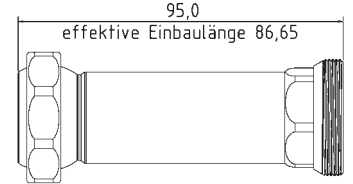
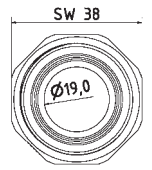

### 3-GE-3

$l = 95$  mm effektiv  $l = 86,6$  mm  
 $l = 95$  mm effective  $l = 86,6$  mm

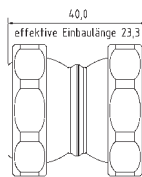
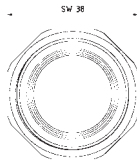

### 3-GE-DK

Grundelement  $l \times 40$  mm effektiv  $l \times 23,3$  mm  
 basic element  $l \times 40$  mm effective  $l \times 23,3$  mm

## Maschinen-/Düsenadapter | Machine-/Nozzle Adapter

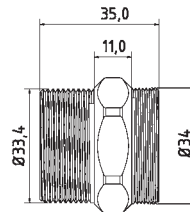
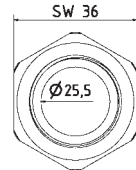
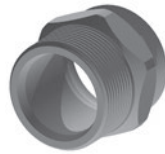

### 3-AD-10-PT

Adapterstück G 1" PT (Withworth-Gewinde)  
 adaptor piece thread G 1" PT (NPT thread)

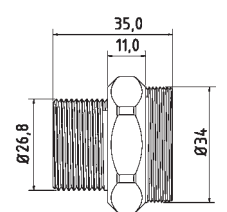
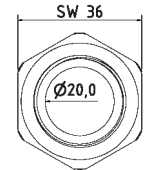
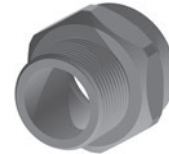

### 3-AD-34-PT

Adapterstück G 3/4" PT (Withworth-Gewinde)  
 adaptor piece thread 3/4" PT (NPT thread)

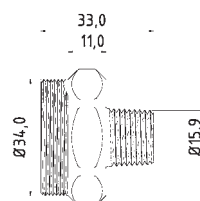
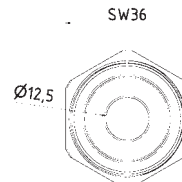

### 3-AD-38-PT

Adapterstück G 3/8" PT (Withworth-Gewinde)  
 adaptor piece thread 3/8" PT (NPT thread)

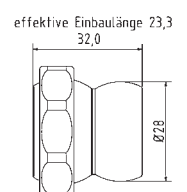
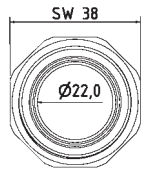
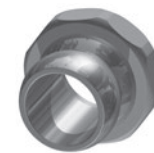

### 3-AD-LL

Adapterstück Loc-Line Typ 3  
 adaptor piece Loc-Line Type 3

## Winkelemente | Elbows

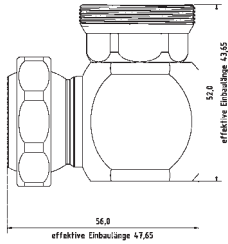
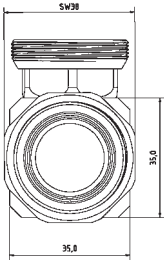

### 3-WV-1K

Winkelverschraubung mit Kugelstück  
*elbow piece movable*

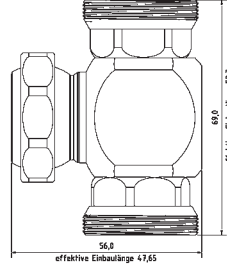
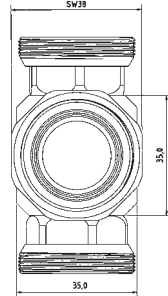
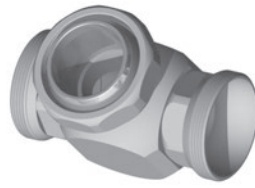

### 3-WV-2K

T-Stück mit Kugelstück  
*T-piece movable*

## Düsen | Nozzles

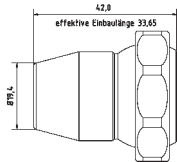
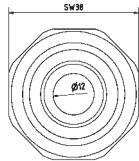

### 3-DU-12

Düse gerade Bohrung Ø 12 mm  
*nozzle straight Ø 12 mm*

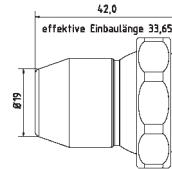
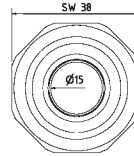
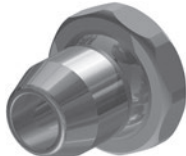

### 3-DU-15

Düse gerade Bohrung Ø 15 mm  
*nozzle straight Ø 15 mm*

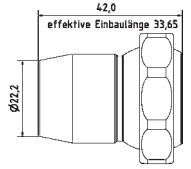
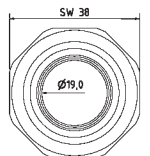
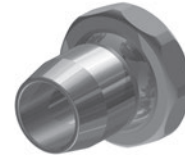

### 3-DU-19

Düse gerade Bohrung Ø 19 mm  
*nozzle straight Ø 19 mm*

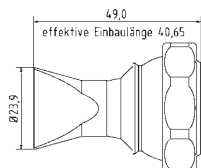
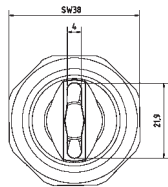

### 3-DU-SL-25

Flachdüse Schlitzbreite 22 x 4,0 mm  
Streustrahl  
*flat nozzle broadly with slit 22 x 4,0 mm  
scattered beam*

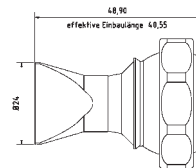
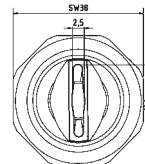

### 3-DU-SL-25-SS

Flachdüse Schlitzbreite 20 x 2,5 mm  
Streustrahl  
*flat nozzle broadly with slit 20 x 2,5 mm  
scattered beam*

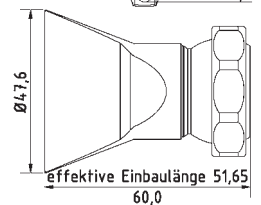
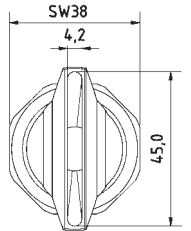
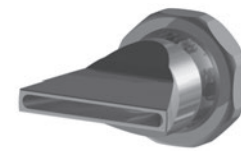

### 3-DU-SL-50

Flachdüse Schlitzbreite 45 x 4,2 mm  
Streustrahl  
*flat nozzle broadly with slit 45 x 4,2 mm  
scattered beam*

# Typ3 [3/4" System]

## Düsen | Nozzles

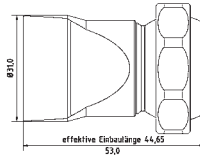
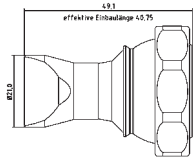
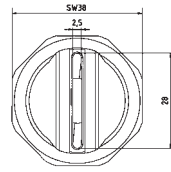
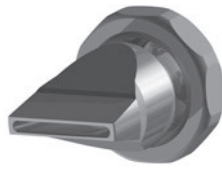
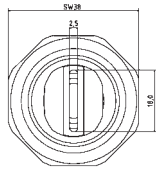
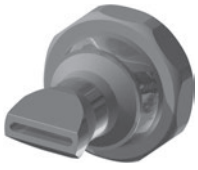

### 3-DU-SL-25-GS

Flachdüse Schlitzbreite 18 x 2,5 mm  
gerader Strahl  
*flat nozzle broadly with slit 18 x 2,5 mm  
straight jet*

### 3-DU-SL-31-GS

Flachdüse Schlitzbreite 28 x 2,5 mm  
gerader Strahl  
*flat nozzle broadly with slit 28 x 2,5 mm  
straight jet*

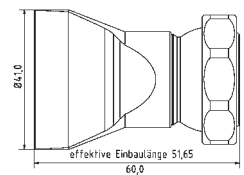
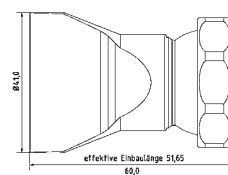
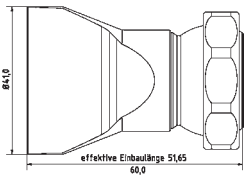
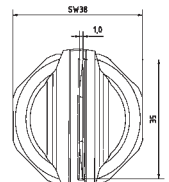
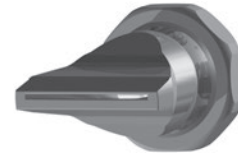
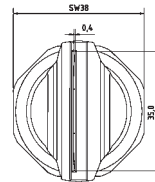
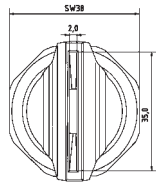
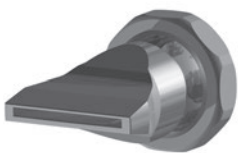

### 3-DU-SL-50-GS

Flachdüse Schlitzbreite 35 x 2,0 mm  
gerader Strahl  
*flat nozzle broadly with slit 35 x 2,0 mm  
straight jet*

### 3-DU-SL-50-GS-0.4

Flachdüse Schlitzbreite 35 x 0,4 mm  
gerader Strahl  
*flat nozzle broadly with slit 35 x 0,4 mm  
straight jet*

### 3-DU-SL-50-GS-1.0

Flachdüse Schlitzbreite 35 x 1,0 mm  
gerader Strahl  
*flat nozzle broadly with slit 35 x 1,0 mm  
straight jet*

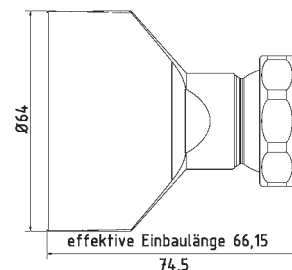
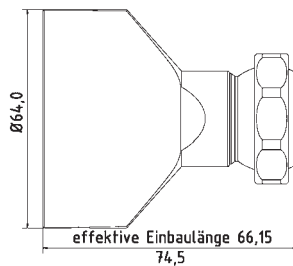
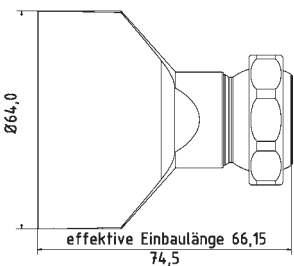
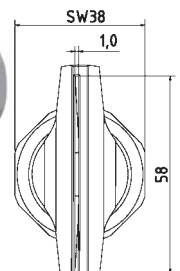
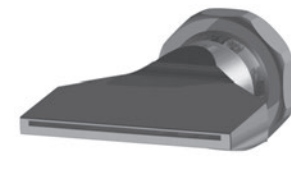
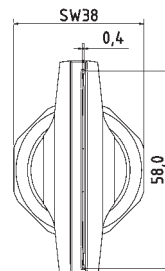
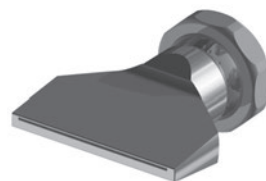
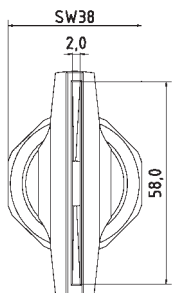
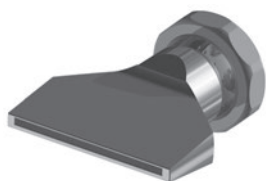

### 3-DU-SL-65-GS

Flachdüse Schlitzbreite 58 x 2,0 mm  
gerader Strahl  
*flat nozzle broadly with slit 58 x 2,0 mm  
straight jet*

### 3-DU-SL-65-GS-0.4

Flachdüse Schlitzbreite 58 x 0,4 mm  
gerader Strahl  
*flat nozzle broadly with slit 58 x 0,4 mm  
straight jet*

### 3-DU-SL-65-GS-1.0

Flachdüse Schlitzbreite 58 x 1,0 mm  
gerader Strahl  
*flat nozzle broadly with slit 58 x 1,0 mm  
straight jet*

Düsen | Nozzles

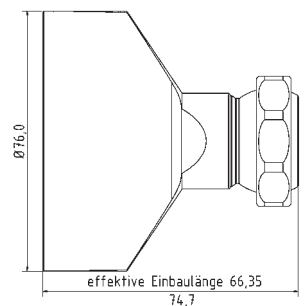
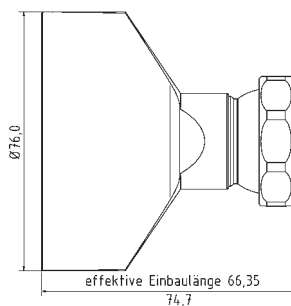
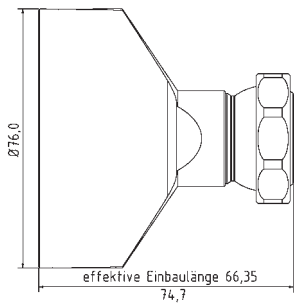
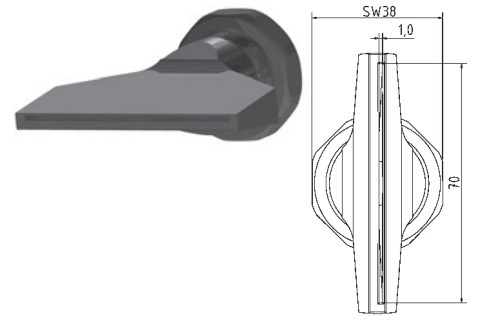
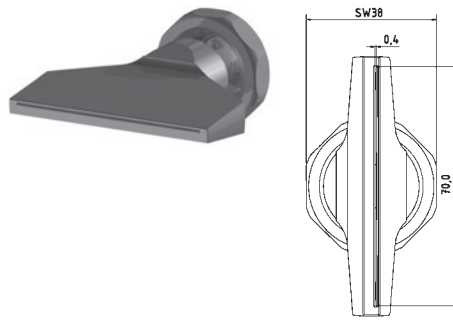
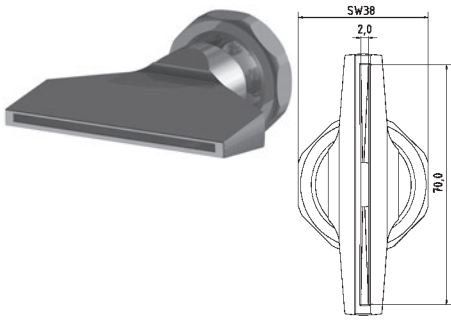

**3-DU-SL-76-GS**

Flachdüse Schlitzbreite 70 x 2,0 mm  
gerader Strahl  
*flat nozzle broadly with slit 70 x 2,0 mm  
straight jet*

**3-DU-SL-76-GS-0.4**

Flachdüse Schlitzbreite 70 x 0,4 mm  
gerader Strahl  
*flat nozzle broadly with slit 70 x 0,4 mm  
straight jet*

**3-DU-SL-76-GS-1.0**

Flachdüse Schlitzbreite 70 x 1,0 mm  
gerader Strahl  
*flat nozzle broadly with slit 70 x 1,0 mm  
straight jet*

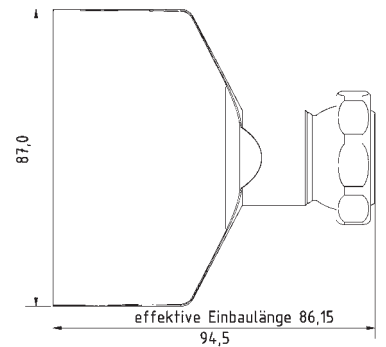
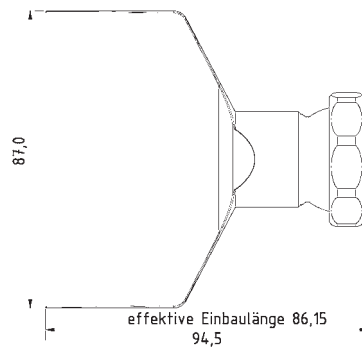
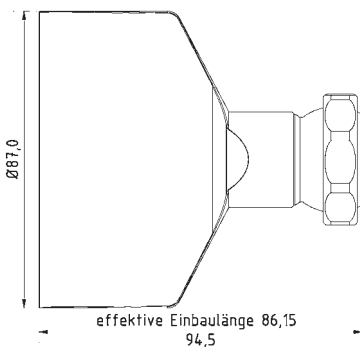
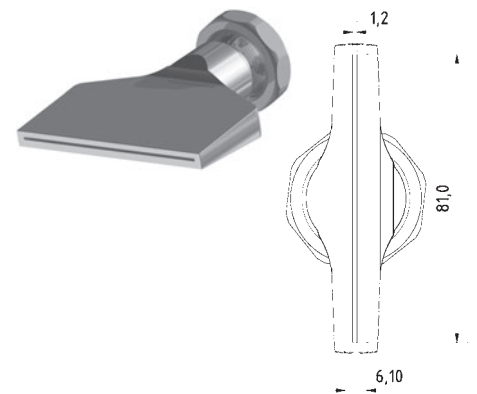
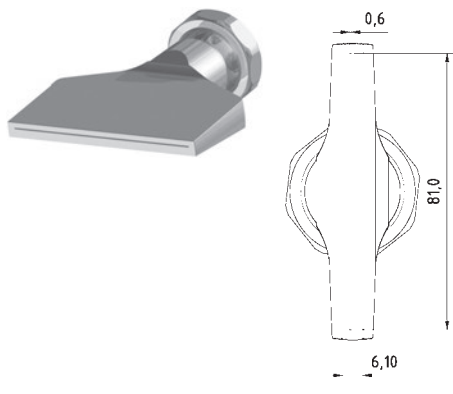
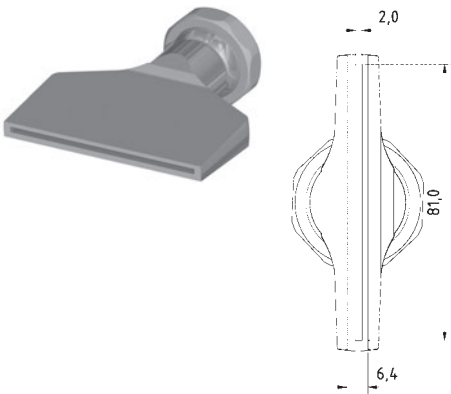

**3-DU-SL-87-GS**

Flachdüse Schlitzbreite 81 x 2,0 mm  
gerader Strahl  
*flat nozzle broadly with slit 81 x 2,0 mm  
straight jet*

**3-DU-SL-87-GS-0.6**

Flachdüse Schlitzbreite 81 x 0,6 mm  
gerader Strahl  
*flat nozzle broadly with slit 81 x 0,6 mm  
straight je*

**3-DU-SL-87-GS-1.2**

Flachdüse Schlitzbreite 81 x 1,2 mm  
gerader Strahl  
*flat nozzle broadly with slit 81 x 1.2 mm  
straight je*



# Typ3 [3/4" System]

## Düsen | Nozzles

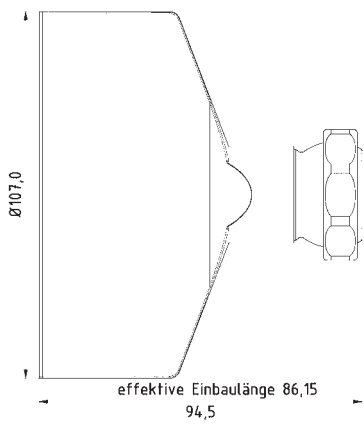
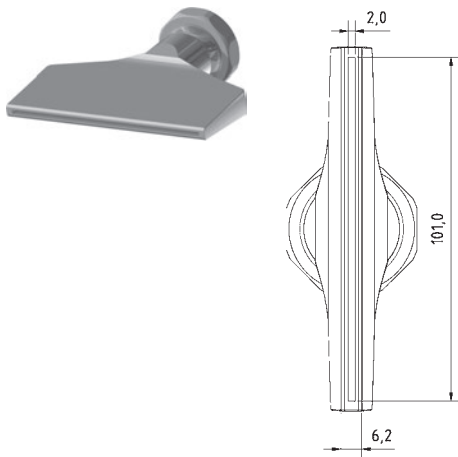

### 3-DU-SL-107-GS

Flachdüse Schlitzbreite 101 x 2,0 mm  
gerader Strahl  
*flat nozzle broadly with slit 101 x 2,0 mm  
straight jet*

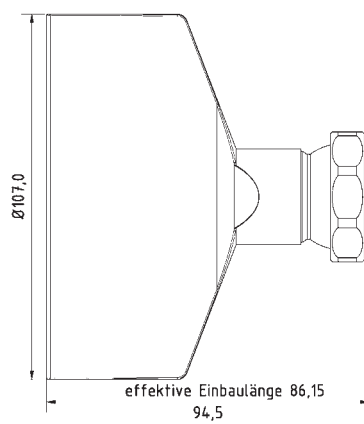
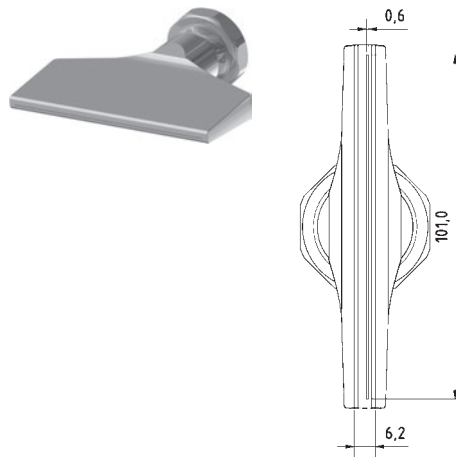

### 3-DU-SL-107-GS-0.6

Flachdüse Schlitzbreite 101 x 0,6 mm  
gerader Strahl  
*flat nozzle broadly with slit 101 x 0,6 mm  
straight jet*

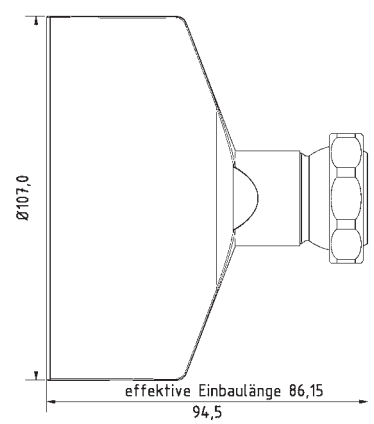
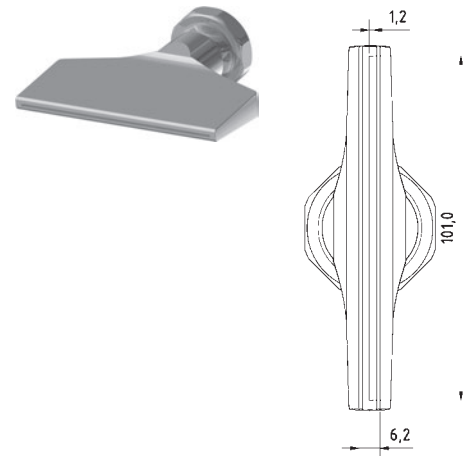

### 3-DU-SL-107-GS-1.2

Flachdüse Schlitzbreite 101 x 1,2 mm  
gerader Strahl  
*flat nozzle broadly with slit 101 x 1,2 mm  
straight jet*

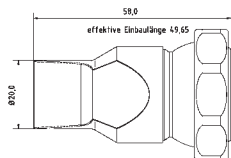
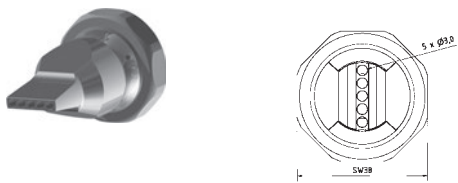

### 3-DU-LL-5-3

Düse gerade mit Bohrungen 5 x Ø 3 mm  
*nozzle straight with holes 5 x Ø 3 mm*

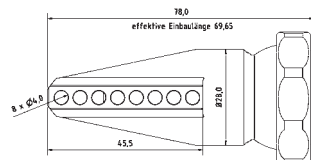
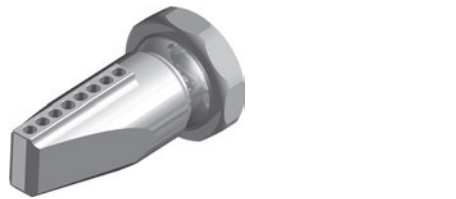

### 3-DU-LL-90-8

Düse 90° mit Bohrungen 8 x Ø 4 mm  
*nozzle 90° with holes 8 x Ø 4 mm*

## Zubehör | Accessories

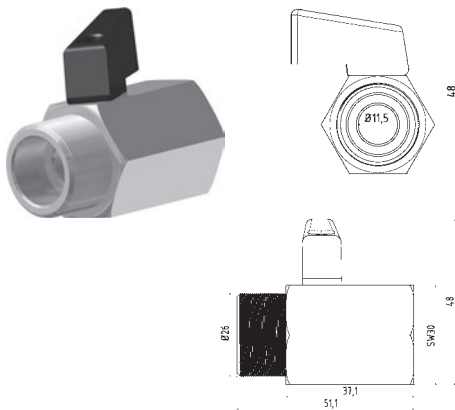

### KH-34

Mini-Kugelhahn G3/4" Messing Verchromt  
mini ball valve thread 3/4" brass chrome-plated



### 3-SW-27

Schlüssel aus Stahl SW 27  
open end wrench SW 27



### 3-SW-38

Schlüssel aus Stahl SW 38  
open end wrench SW 38

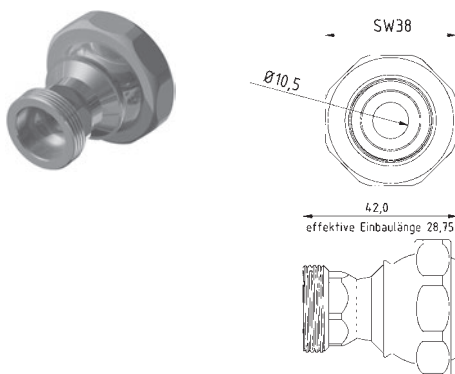

### 3-MU

Mutter Standard  
screw nut (default)

### RE-3-2

Reduktion Typ 3 auf Typ 2  
reduction Type 3 to Type 2

## Grundset | Basic Set

### 3-GS

Grundset Typ3 3/4" Zoll System L = 320 mm  
basic set Type3 3/4" system l = 320 mm

4 x 3-GE, 1 x 3-GE-2, 1 x 3-GE-3,  
1 x 3-AD-34PT, 1 x 3-AD-10PT, 1 x 3-DU-12,  
1 x 3-DU-15, 1 x 3-SW-27, 1 x 3-SW-38

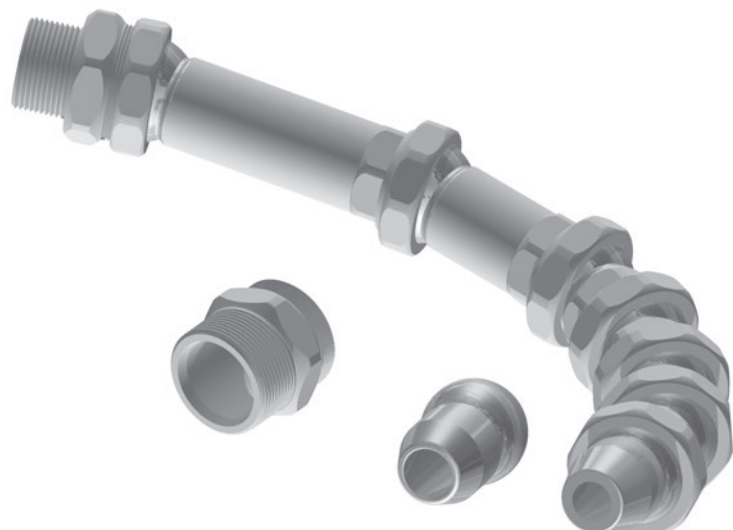

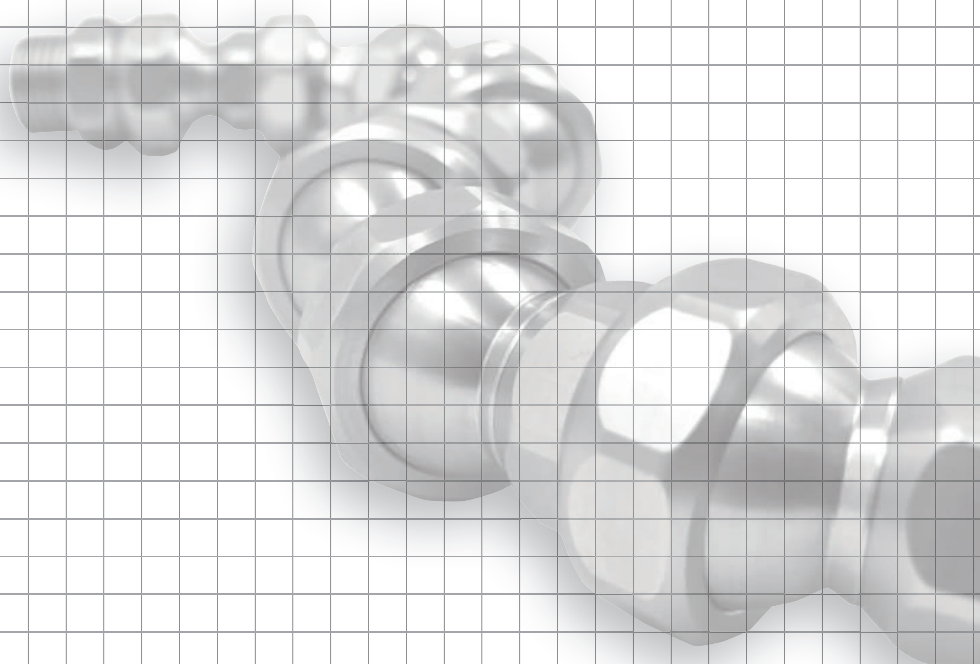

SCHNELLER UND

LEISTUNGSFÄHIGER

SUPPORT

Wir beraten Sie gerne persönlich  
über die Vorteile unserer  
Kühl-Schmierstoff-Leitungssysteme

**Hirt**<sup>®</sup>  
**LINE**

[www.kuehlmittelschlauch.com](http://www.kuehlmittelschlauch.com)

**Hirt-Line Europe**

Seestr. 16  
CH-8268 Salenstein

Tel.: +41 (0)71 53 43 959  
Fax: +41 (0)71 53 43 953  
[info@hirt-line-europe.com](mailto:info@hirt-line-europe.com)

Abbildungen können vom Original abweichen. Änderungen der technischen Daten jederzeit ohne Vorankündigung vorbehalten. Jede Nachbildung des Produktes, gleich ob ganz oder teilweise, sowie der zugehörigen Technologien ist untersagt. Hirt-Line® ist ein registrierter Name. Technische Änderungen und Irrtümer vorbehalten.  
All illustrations are for reference only. The technical datas are subject to change. A copy of the product, whether in whole or in part, and the related technologies is prohibited.  
Hirt-Line® is a registered name. Technical amendmends and errors may occur.